

ELKE

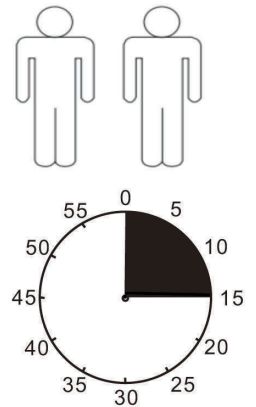

1

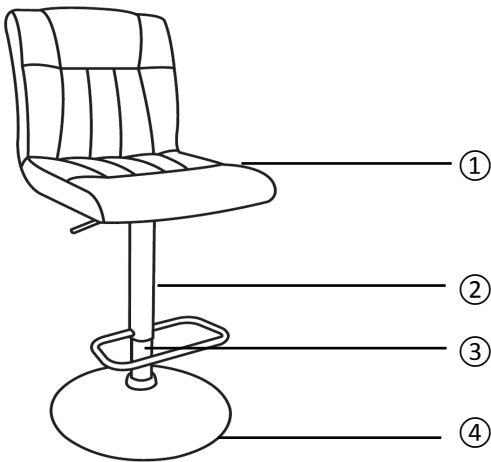
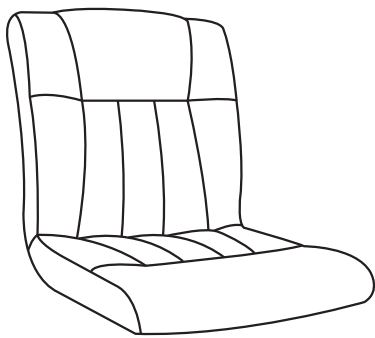

2

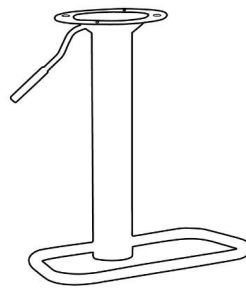

3



4

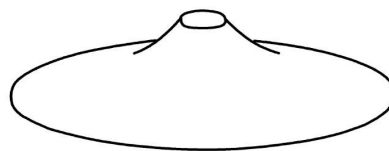

1	1x
2	1x
3	1x
4	1x

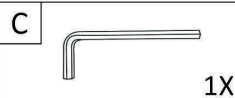
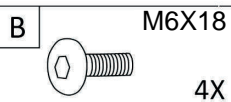
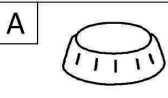

I.

1.

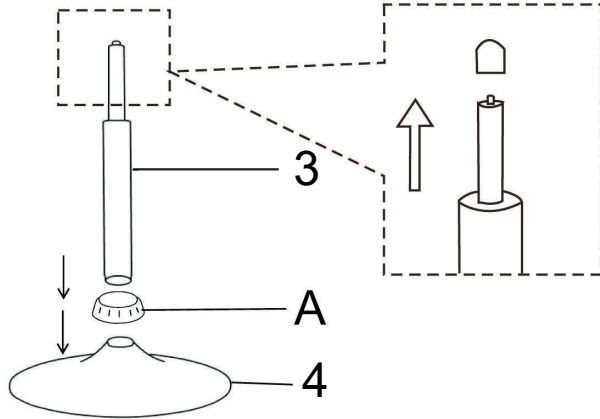

A

1X

75%

2.

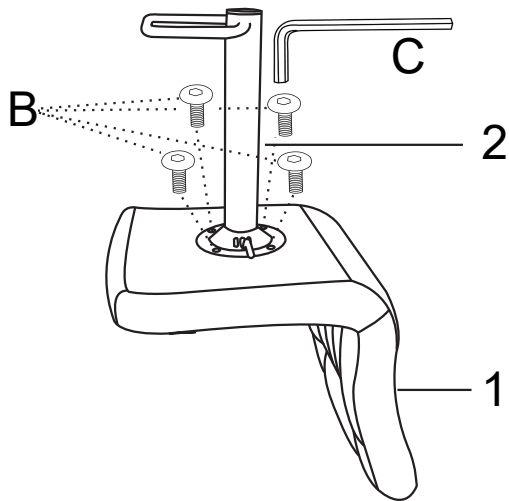

B

M6X18

4X

C

1X

100%



3.

