

ERIKA

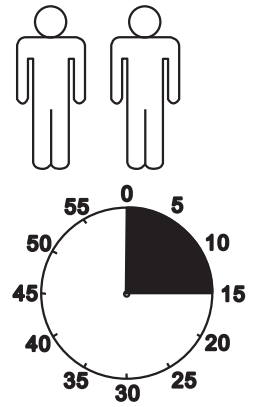

1

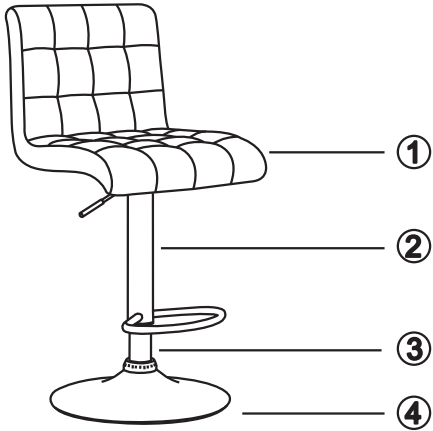
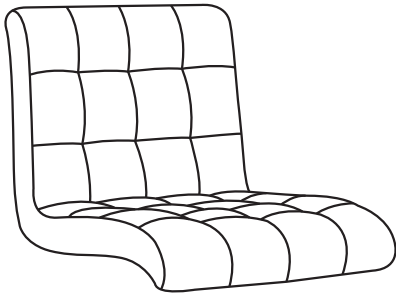

2

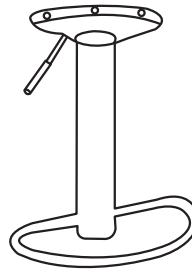

3



4

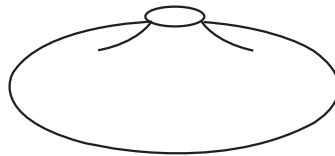

1	1x
2	1x
3	1x
4	1x



1/1



1x

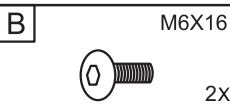

2x

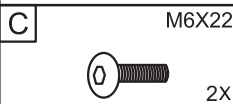

2x

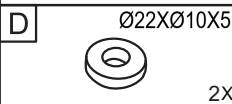

2x





1x

I.

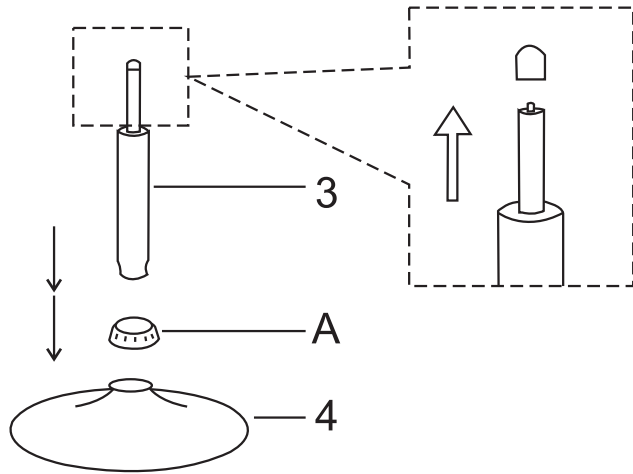
1.





A  1X

 75%

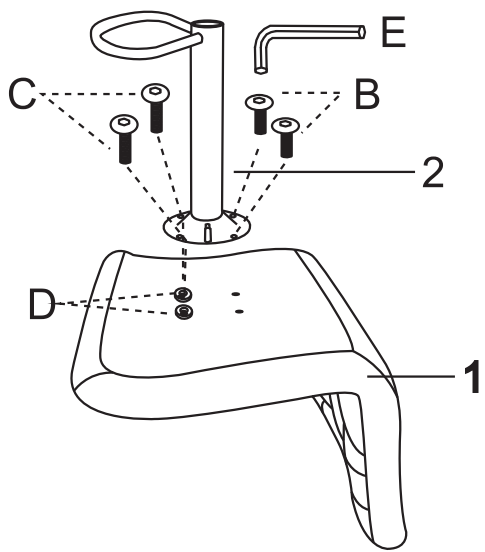
2.



B  M6X16 2X

C  M6X22 2X

D  Ø22XØ10X5 2X

E  1X

 100%

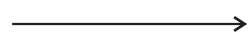

3.

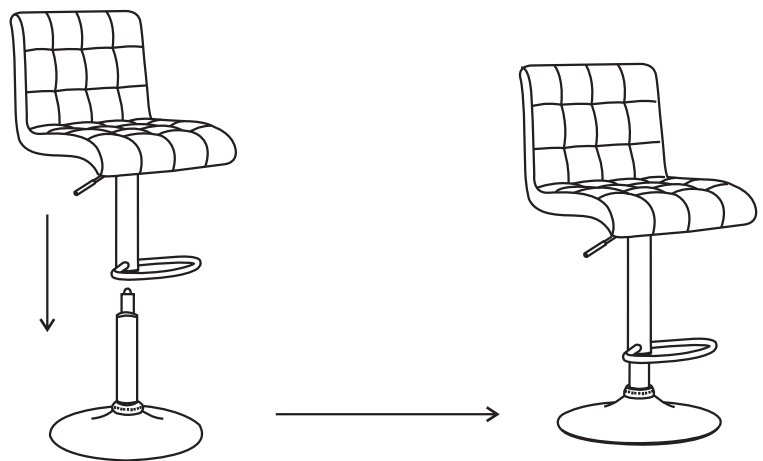

LE TRI + FACILE  **BAC DE TRI**

Séparez les éléments avant de trier