

POCO line®
EXKLUSIV UND PREISWERT

MONTAGE ANLEITUNG ASSEMBLY INSTRUCTION

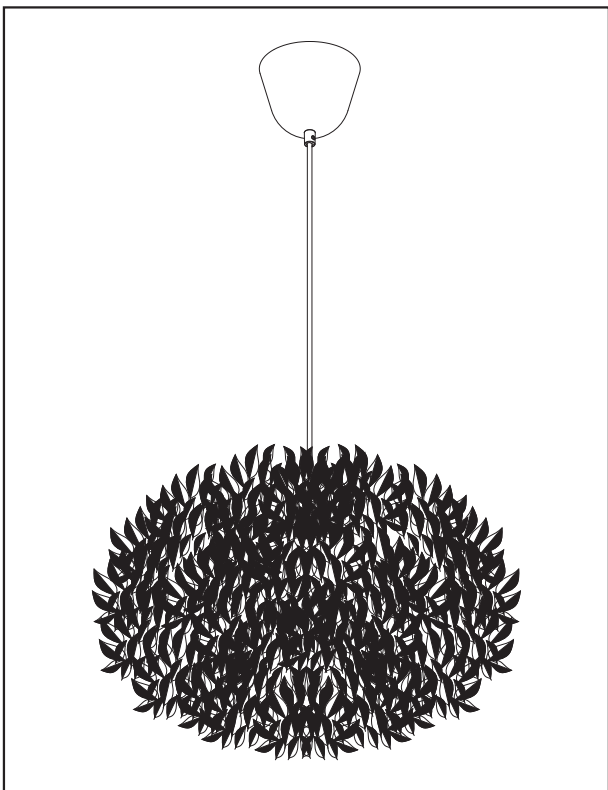

DUCKY



LICHTQUELLE LIGHTING SOURCE	E27 1 X Max.15W LED	INKLUSIVE INCLUDED	<input type="checkbox"/>
		NICHT INKLUSIVE NOT INCLUDED	<input checked="" type="checkbox"/>

WERKZEUGE TOOLS		INKLUSIVE INCLUDED	<input type="checkbox"/>
		NICHT INKLUSIVE NOT INCLUDED	<input checked="" type="checkbox"/>
		NICHT NÖTIG NOT NECESSARY	<input type="checkbox"/>

EISENWAREN HARDWARE		INKLUSIVE INCLUDED	<input checked="" type="checkbox"/>
		NICHT INKLUSIVE NOT INCLUDED	<input type="checkbox"/>
		NICHT NÖTIG NOT NECESSARY	<input type="checkbox"/>

1

Ø6mm
A
B

X1

2

10mm

X1

3

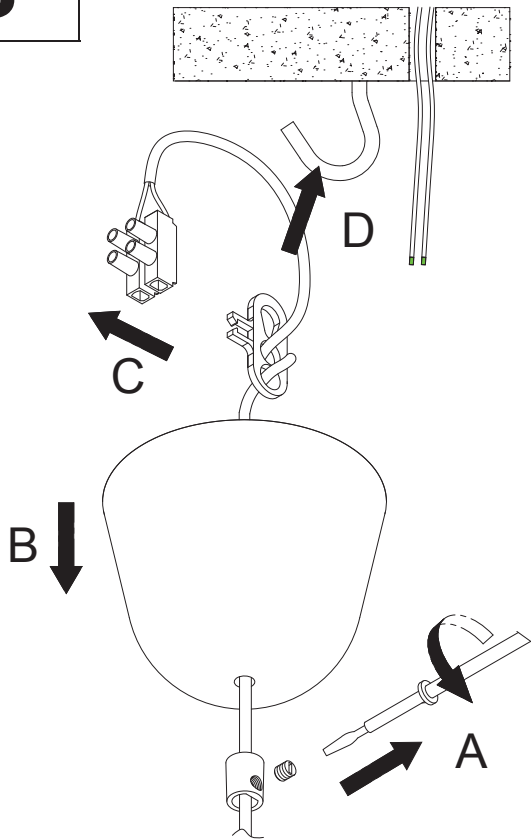

4

L = Braun or Brown
 N = Blau or Blue

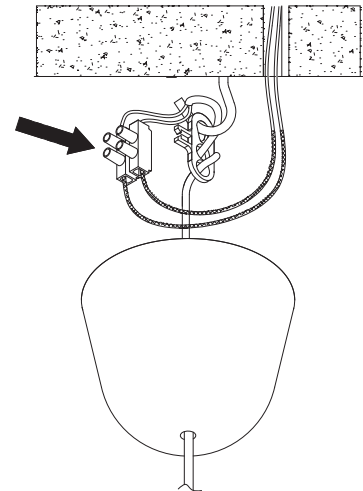
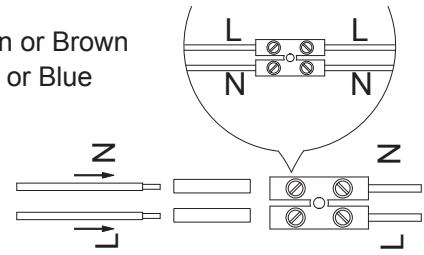

5

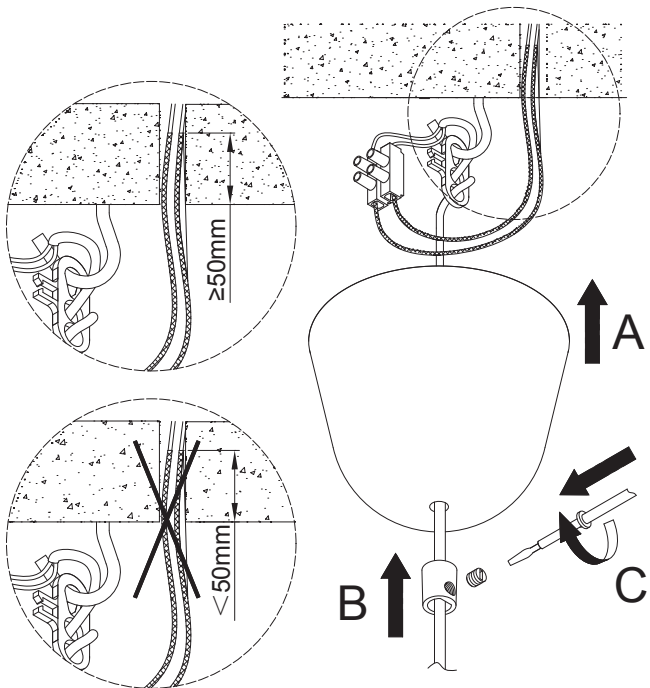

6

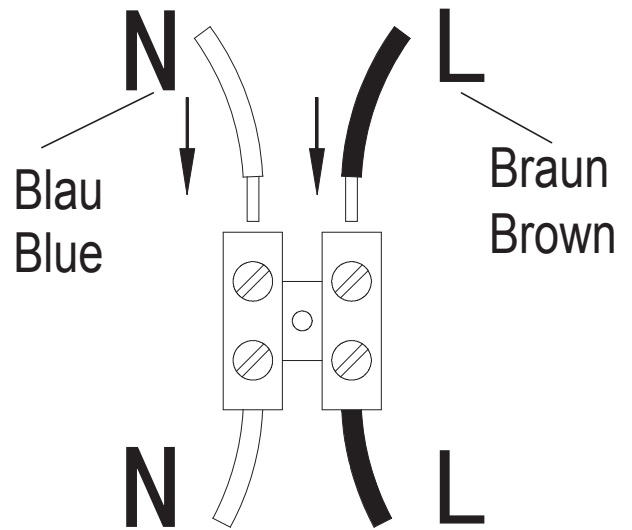

7

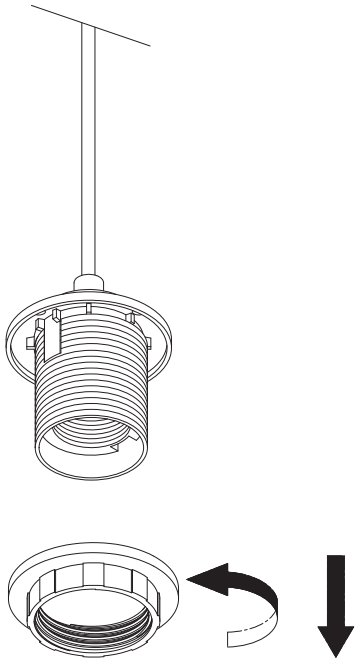

8

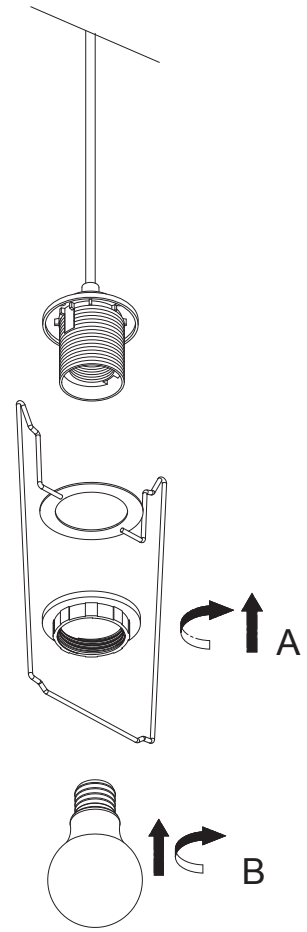

9

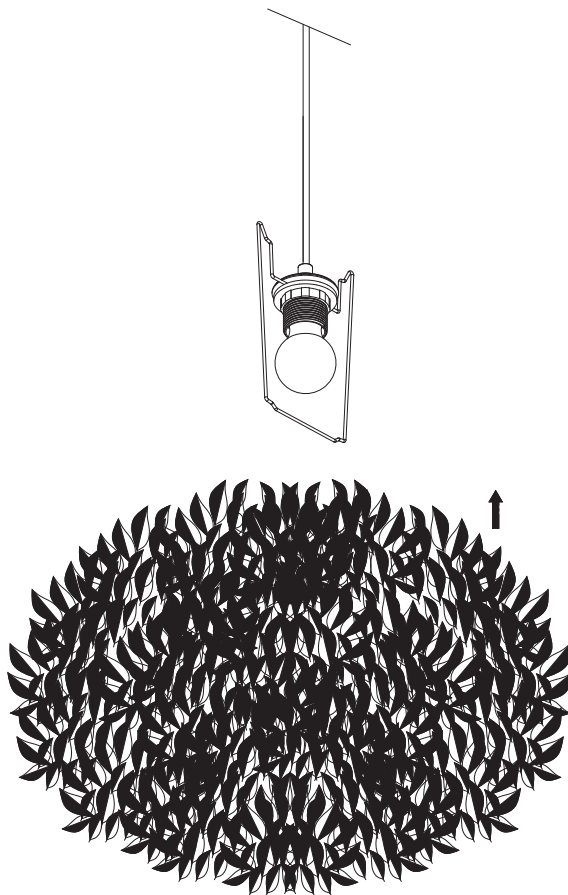

DE: Ersetzen Sie ausgefallene Lampen sofort durch Lampen mit gleicher Nennspannung und Leistung, um Überhitzung zu vermeiden. Trennen Sie die Lampe vom Stromnetz und warten Sie, bis sie abgekühlt ist. Ersetzen Sie die alte Lampe durch eine neue Lampe mit den gleichen Eigenschaften wie die zuvor angegebenen. Folgen Sie den Hinweisen auf der Zeichnung, wenn Sie die Lampe wechseln.

GB: Replace failed lamps immediately by lamps of the same rated voltage and wattage to prevent overheating. Disconnect the lamp from the electrical supply and wait for it to cool down. Replace the old bulb with a new bulb having the same characteristics as those previously indicated. Follow the indications on the drawing when changing the bulb.

