

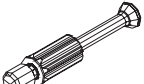



 8x30				 L-84	 7x50	
A 18	B 14	C 10	ZMB 14	D 2	G 6	N 1
 8x50	 4x25					
I 1	E 4	P 4				



NR	L	W	T	COUNT	COLI
1	910	510	16	1	1/1
2	910	510	16	1	1/1
3	508	353	16	1	1/1
4	508	168.5	16	1	1/1
5	510	300	16	1	1/1
6A/6B	200	168.5	16	2	1/1

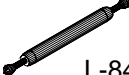

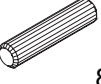

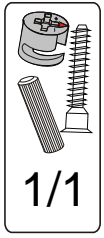
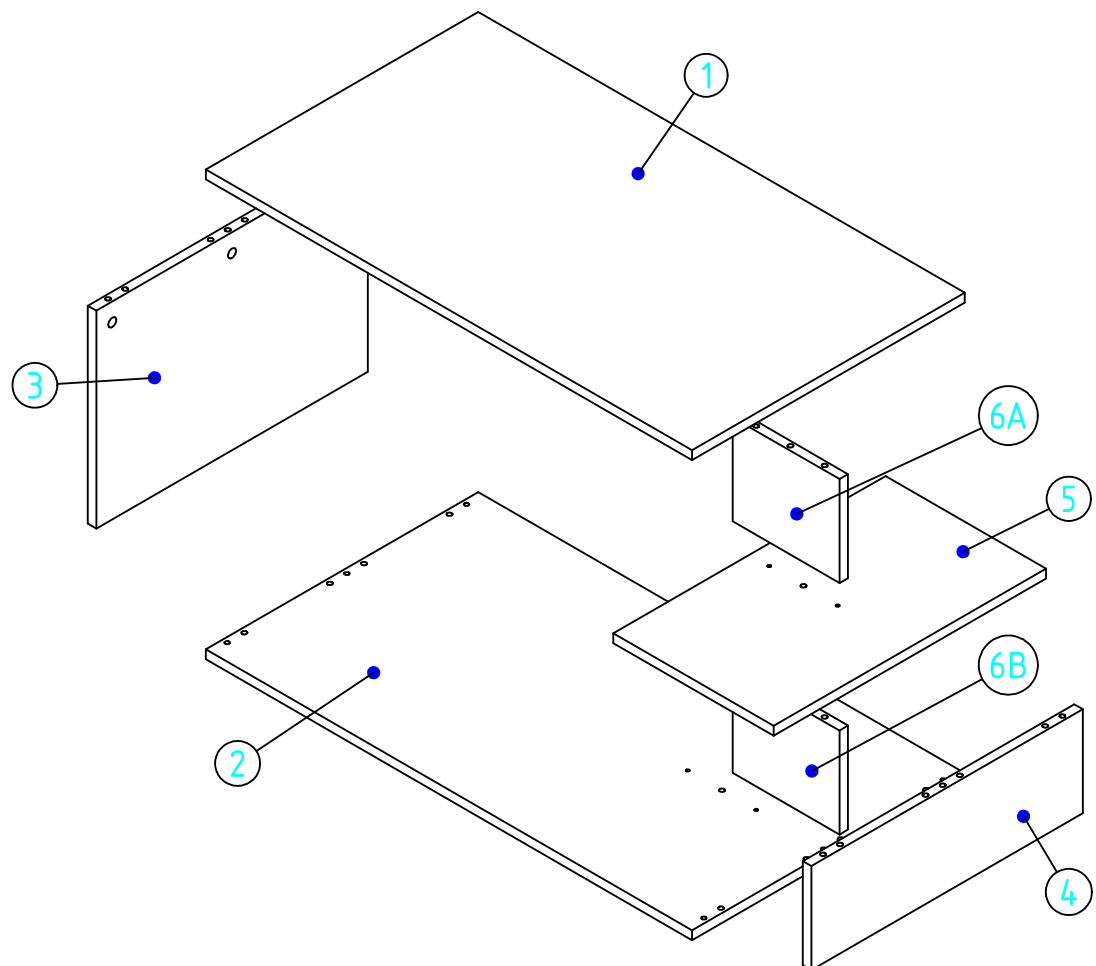
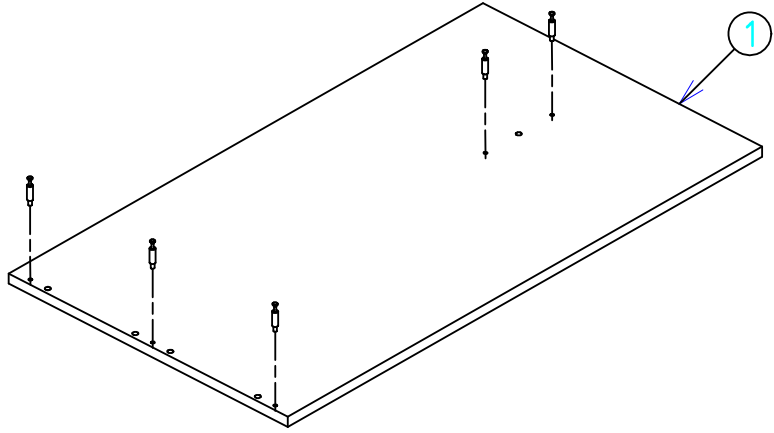
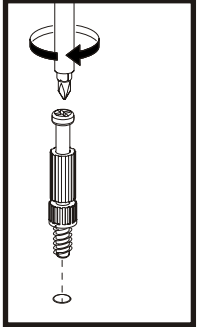
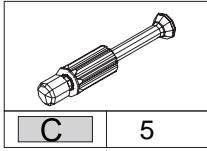
1

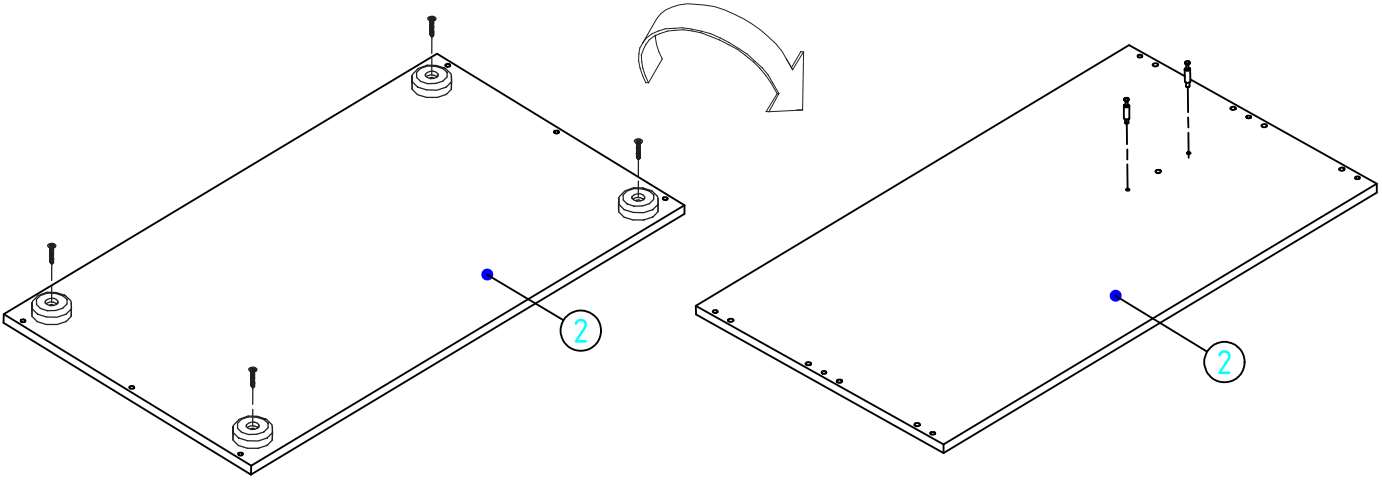
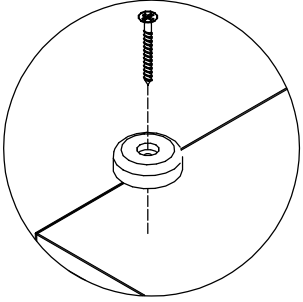
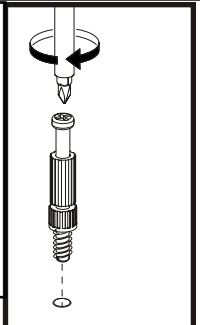
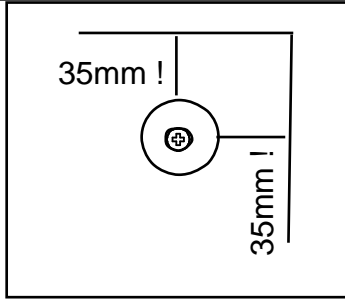
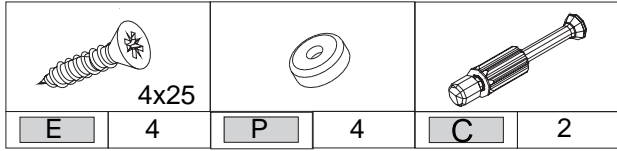

2

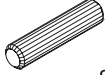

3

	
8x30	
A	16
B	6

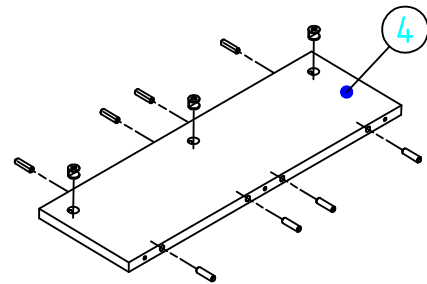
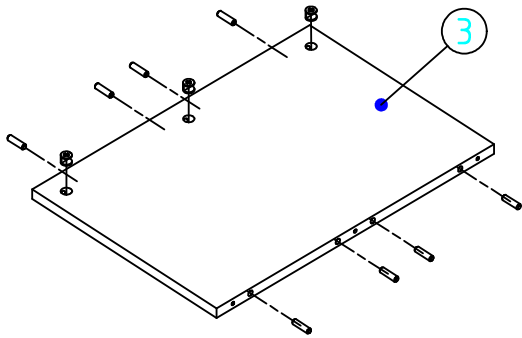
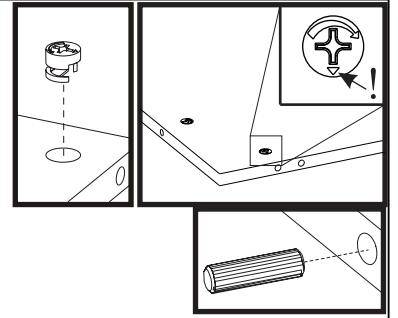

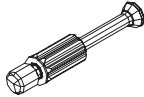

4

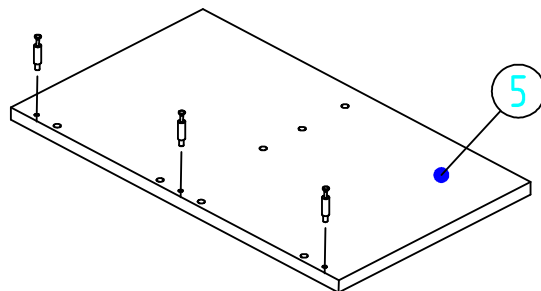
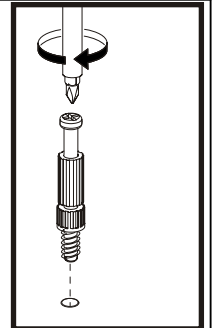
	
C	3

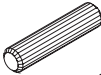

5

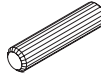
	8x30		8		8x50
A	2	B	8	I	1

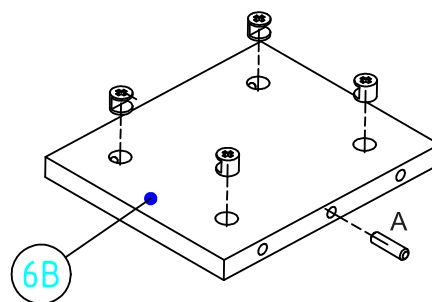
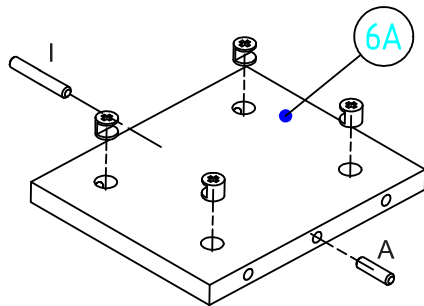

6

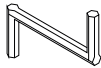
	7x50		1
G	3	N	1

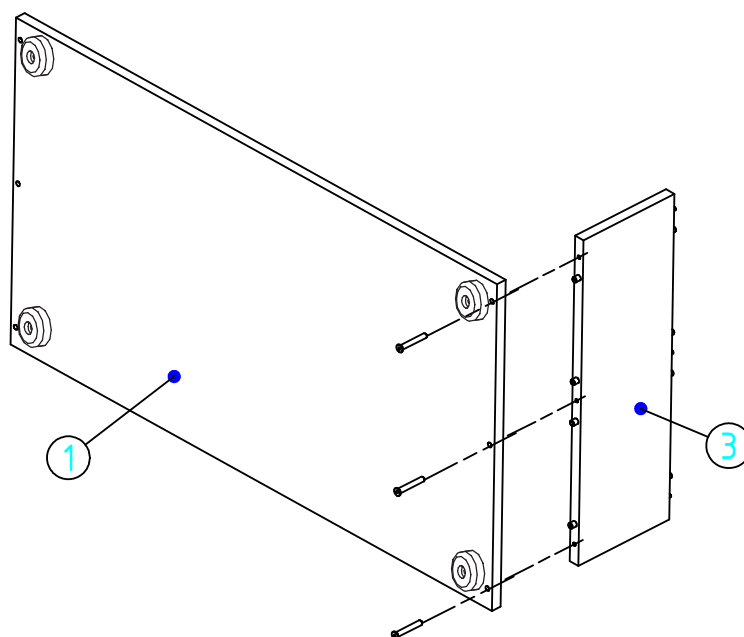
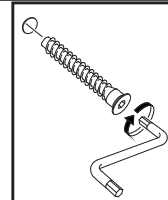

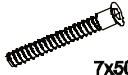
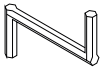

7

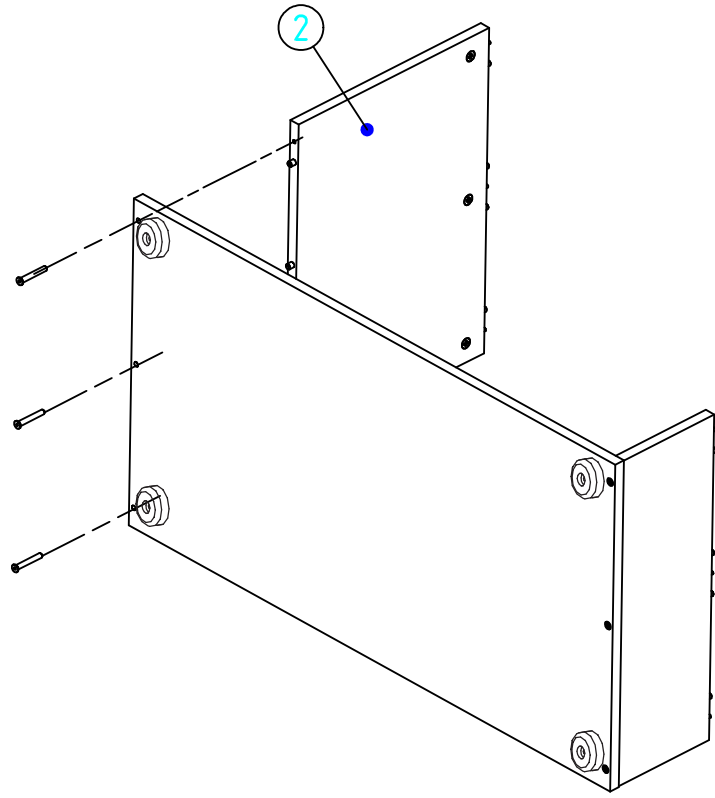
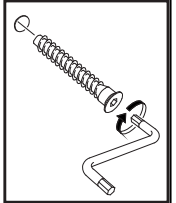
	7x50		N	1
G	3	N	1	

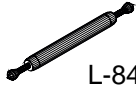

8

	L-84		N	1		ZMB	4
D	2	N	1	ZMB	4		

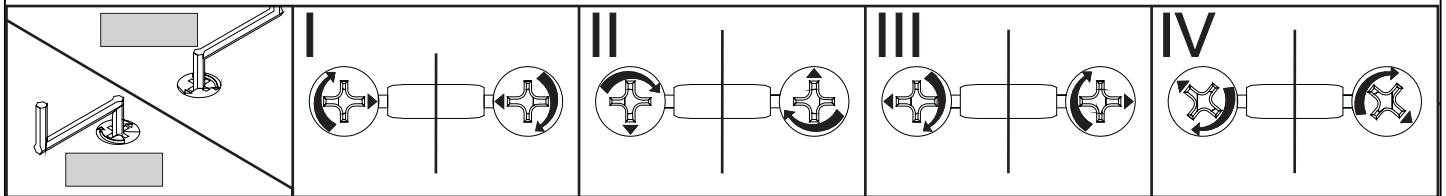
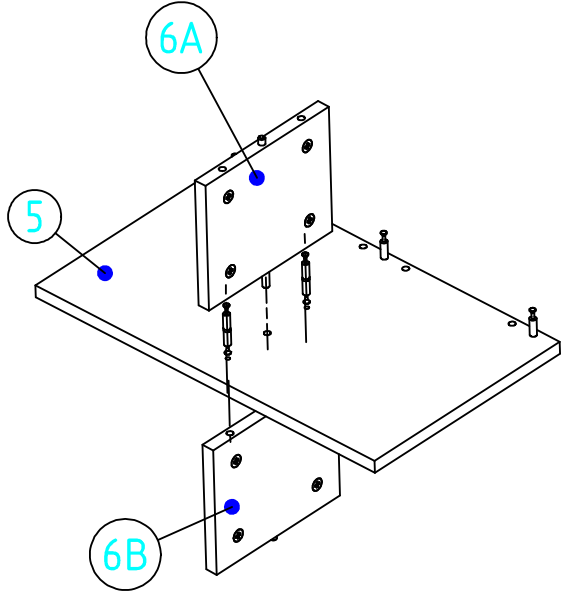
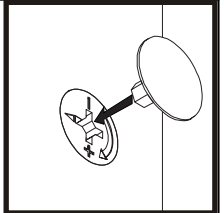

9

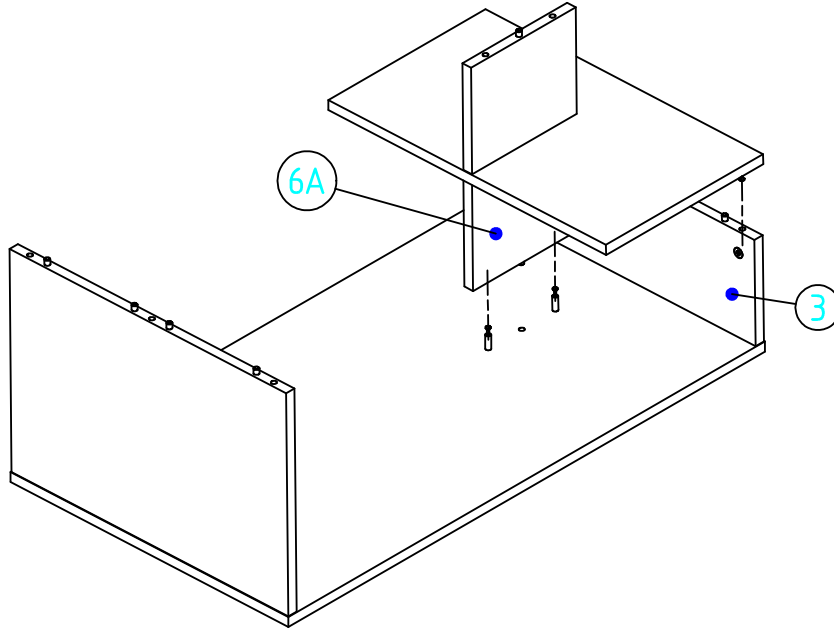
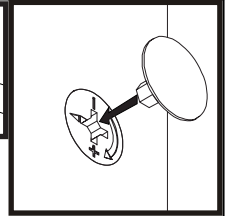
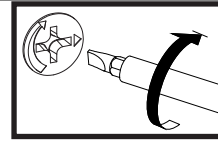
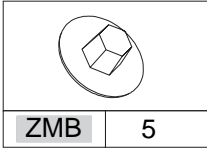

10

