

# SOJAG

produits saisonniers • seasonal products



Sojag code:999-8163186

CUP/UPC code: 772830163186

## Assembly Manual / Guide d'assemblage / Manual de ensamblaje / 조립설명서 / Montageanleitung

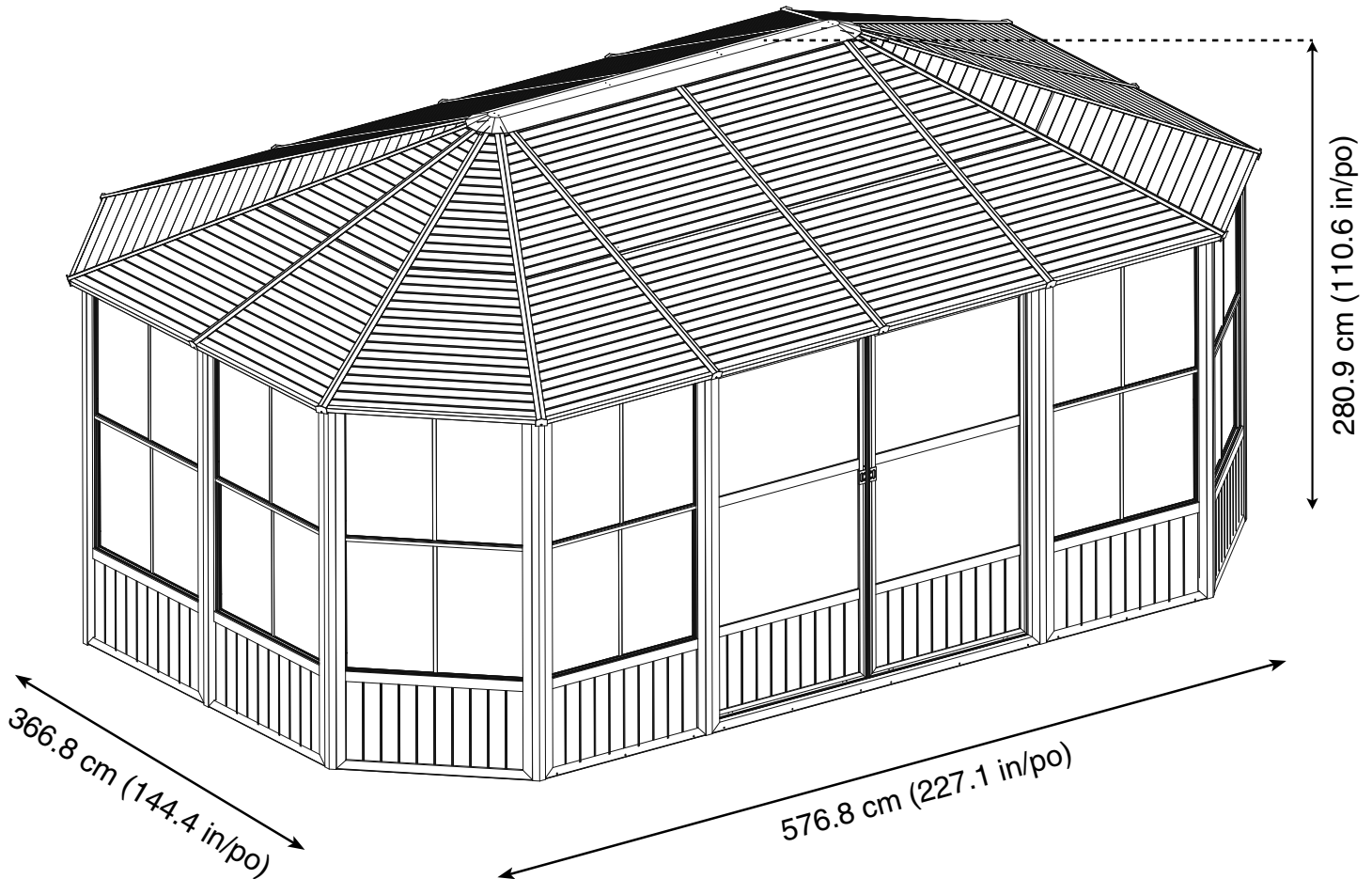

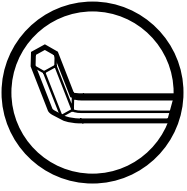

Use the hex keys in the box. / Utiliser les clés hexagonales fournies dans la boîte. /  
Utilice las llaves hexagonales en la caja. / 상자에 육각 키를 사용 하십시오. / Verwenden Sie  
die Sechskantschlüssel in der Box.

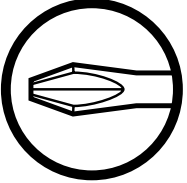

Please use a Phillips screwdriver. / Utiliser un tournevis de type Phillips / Por favor, use  
un destornillador Phillips / 십자 드라이버를 사용 하십시오. / Bitte verwenden Sie einen  
Kreuzschraubenzieher.



You may need to use a drill for this step. / Cette étape peut nécessiter l'utilisation  
d'une perceuse. / puede que tenga que utilizar un taladro para este paso. /  
이 단계에선 드릴을 사용해야 할 수도 있습니다. / Für diesen Schritt können Sie einen  
Bohrer verwenden.



Wearing protective gloves is recommended. / Le port de gants de protection est recommandé /  
El uso de guantes de protección se recomienda / 보호 장갑을 착용 하는 것이 좋습니다. /  
Das Tragen von Schutzhandschuhen wird empfohlen.



Two or more people are required at this stage. / Deux personnes ou plus sont nécessaires à cette  
étape. / Dos o más personas se requieren en esta etapa. / 이 단계에서는 두 명 이상이 필요합니다. /  
Für diesen Bauschritt sind 2 oder mehr Personen erforderlich.



Do not screw firmly for now. / Ne pas visser fermement pour l'instant. / No atornille con  
firmeza por ahora. / 아직 나사를 단단히 조이지 마십시오. / Bitte die Schrauben zum  
jetzigen Zeitpunkt noch nicht fest anziehen.

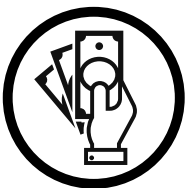

Sold separately / Vendus séparément / vendido en las opciones /  
옵션 판매 / Optional erhältlich

**B6** X 8 (+2)

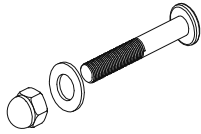

**R** X 2 (+1)

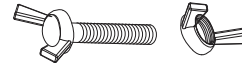

**S** X 64 (+6)

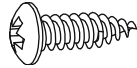

**S1** X 16 (+2)

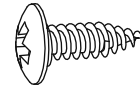

**T** X 40 (+6)

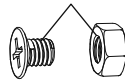

**U** X 80 (+8)

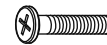

**V** X 70 (+7)



**V1** X 4 (+1)

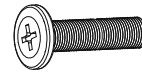

**V2** X 8 (+2)



**V3** X 2 (+1)

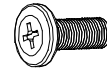

**W** X 12 (+2)

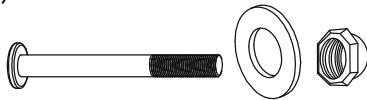

**X** X 12 (+2)

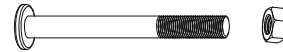

**Y** X 3 (+1)



**Z1** X 8

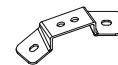

**Z2** X 8

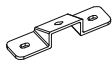



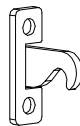



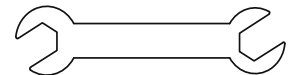

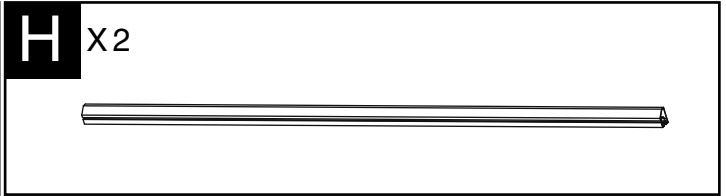
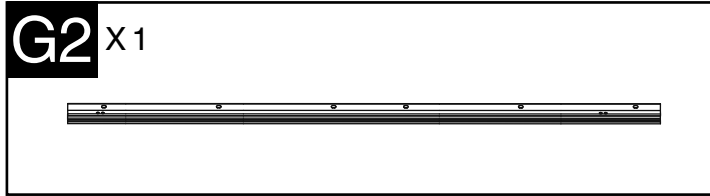
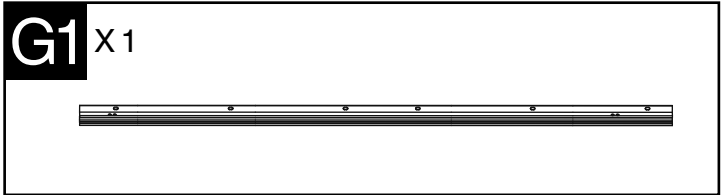
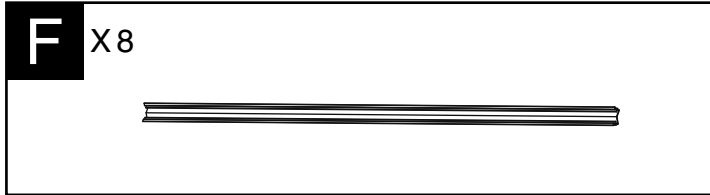
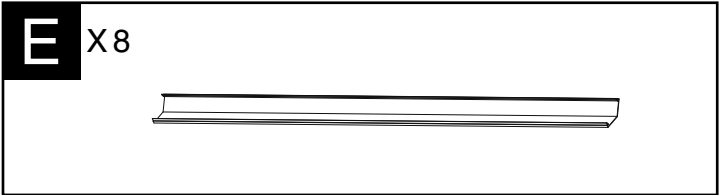
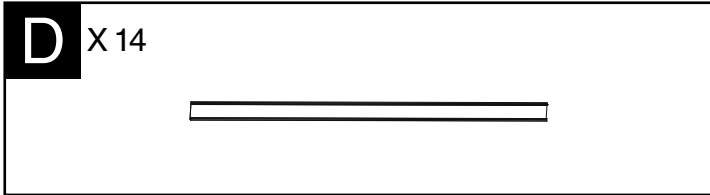
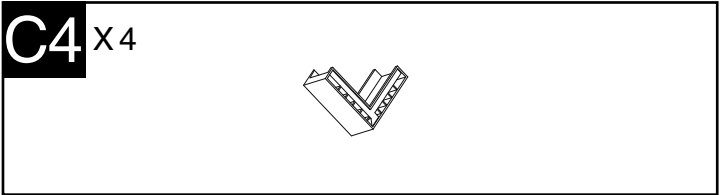
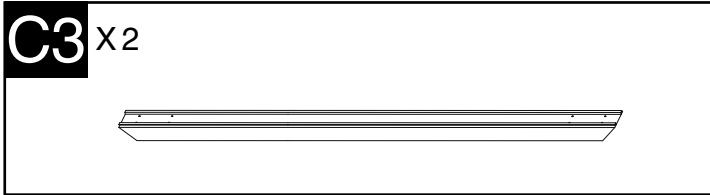
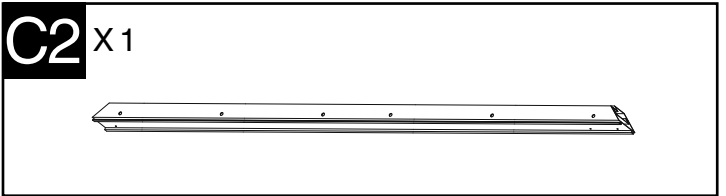
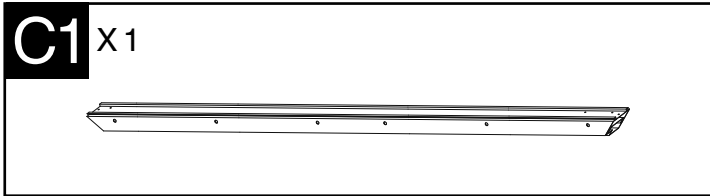
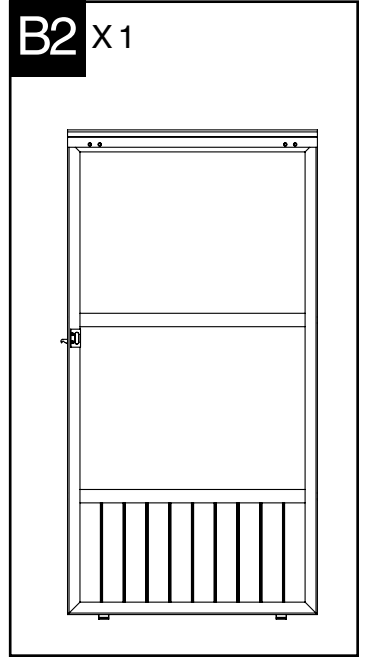
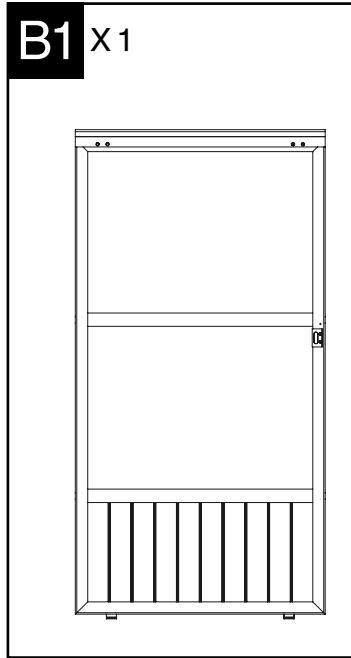
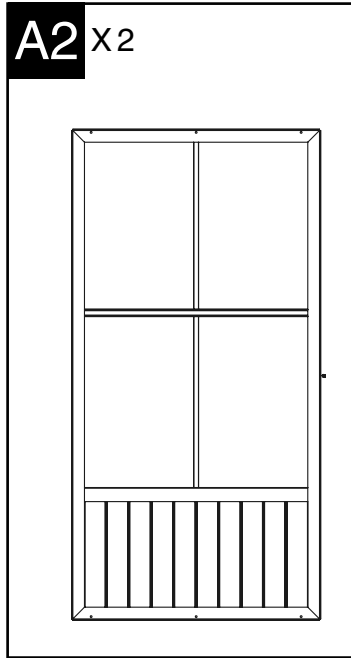
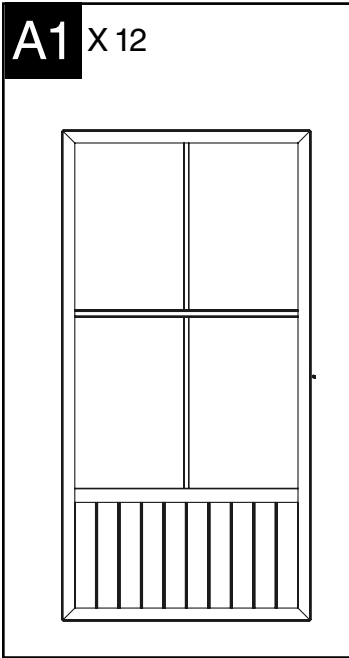



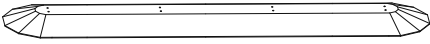

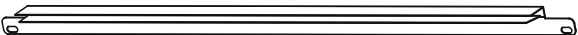
**Z3** X 1

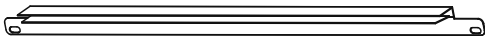

**Z4** X 1



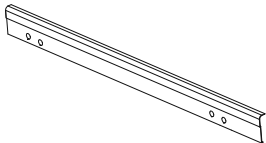

|   |   |
|---|---|
| <b>I</b> X4<br>    | <b>J</b> X1<br>     |
| <b>K</b> X1<br>    | <b>L1</b> X8<br>    |
| <b>L2</b> X8<br>   | <b>M</b> X8<br>     |
| <b>M1</b> X4<br>   | <b>M2</b> X4<br>    |
| <b>N</b> X8<br>  | <b>N1</b> X4<br> |
| <b>N2</b> X4<br> | <b>P</b> X8<br>  |
| <b>P1</b> X4<br> | <b>P2</b> X4<br> |
| <b>O</b> X8<br>  | <b>O1</b> X8<br>  |

|   |
|---|
| <b>B7</b> X2<br> |
|---|

**B5** X4



**Q** X16



**Qa** X4

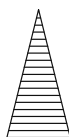

**Qb** X4

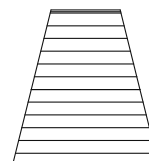

**Qc** X4

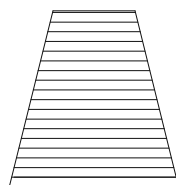

**R1** X2

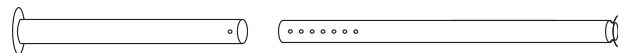

**Ra** X4

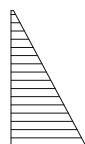

**Rb** X4

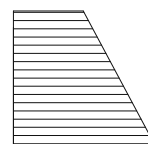

**R1a** X4

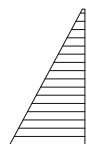

**R1b** X4

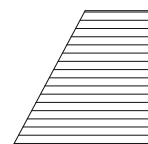

**Sa** X4

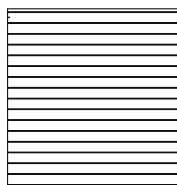

**Sb** X4

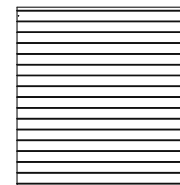

**Z** X3

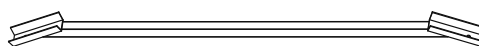

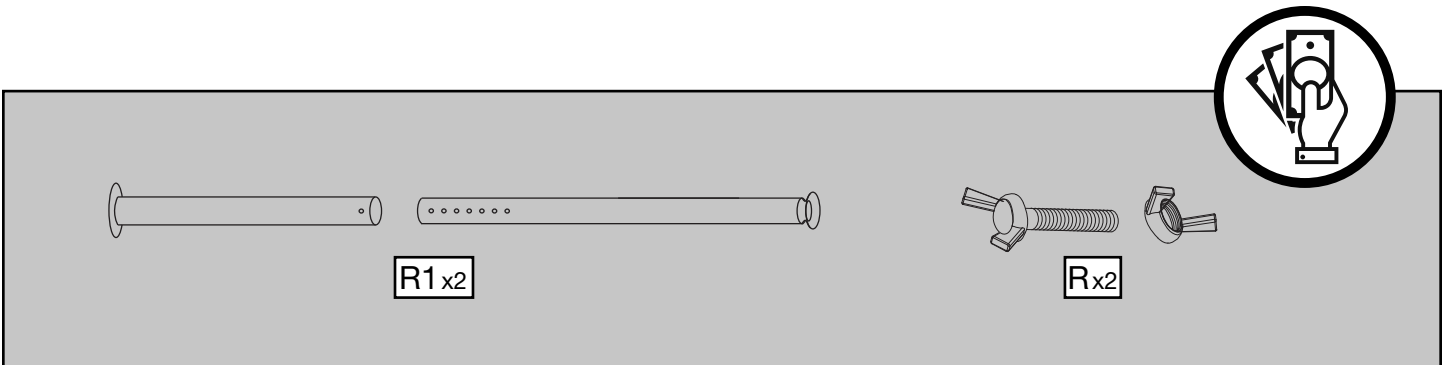
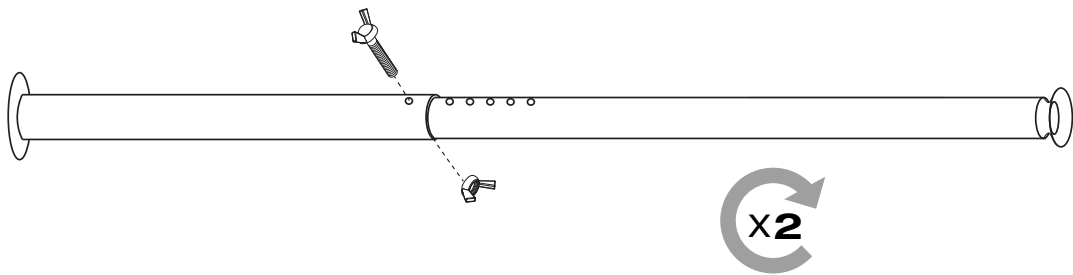
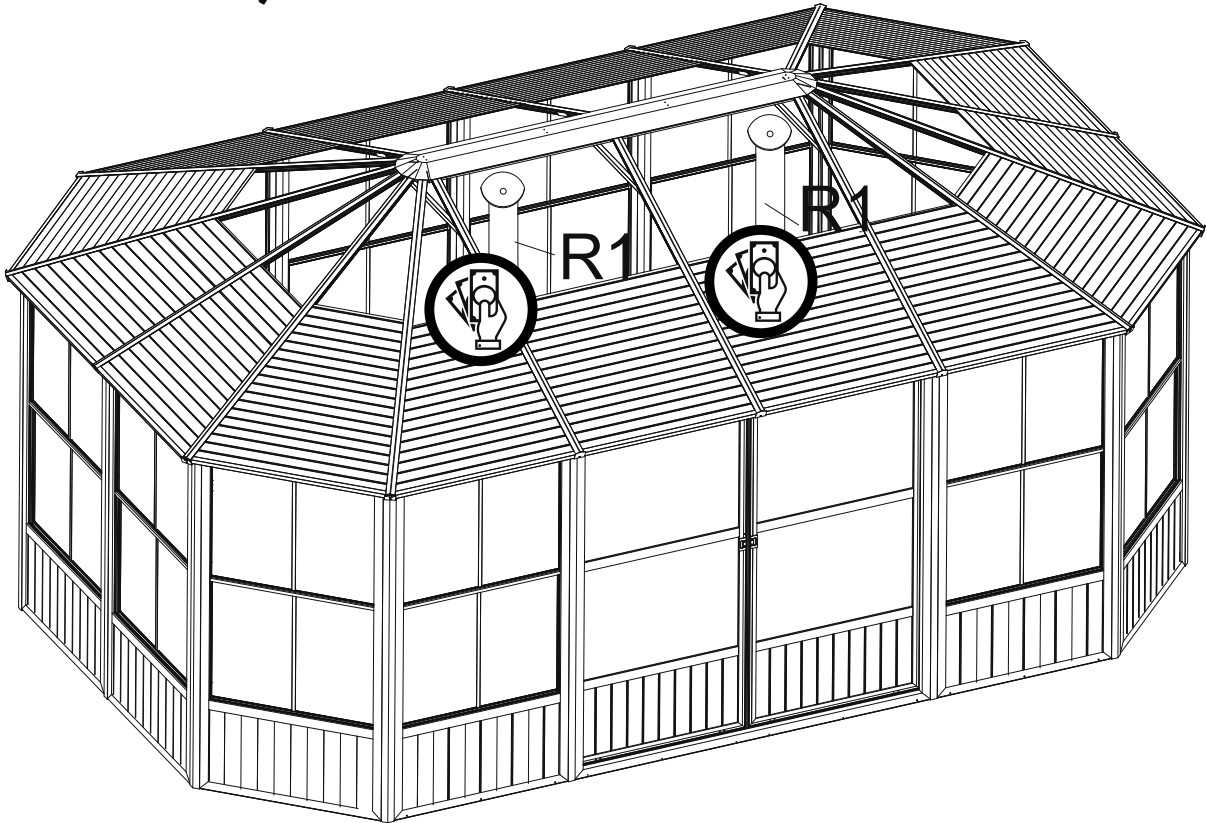
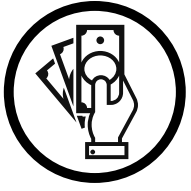

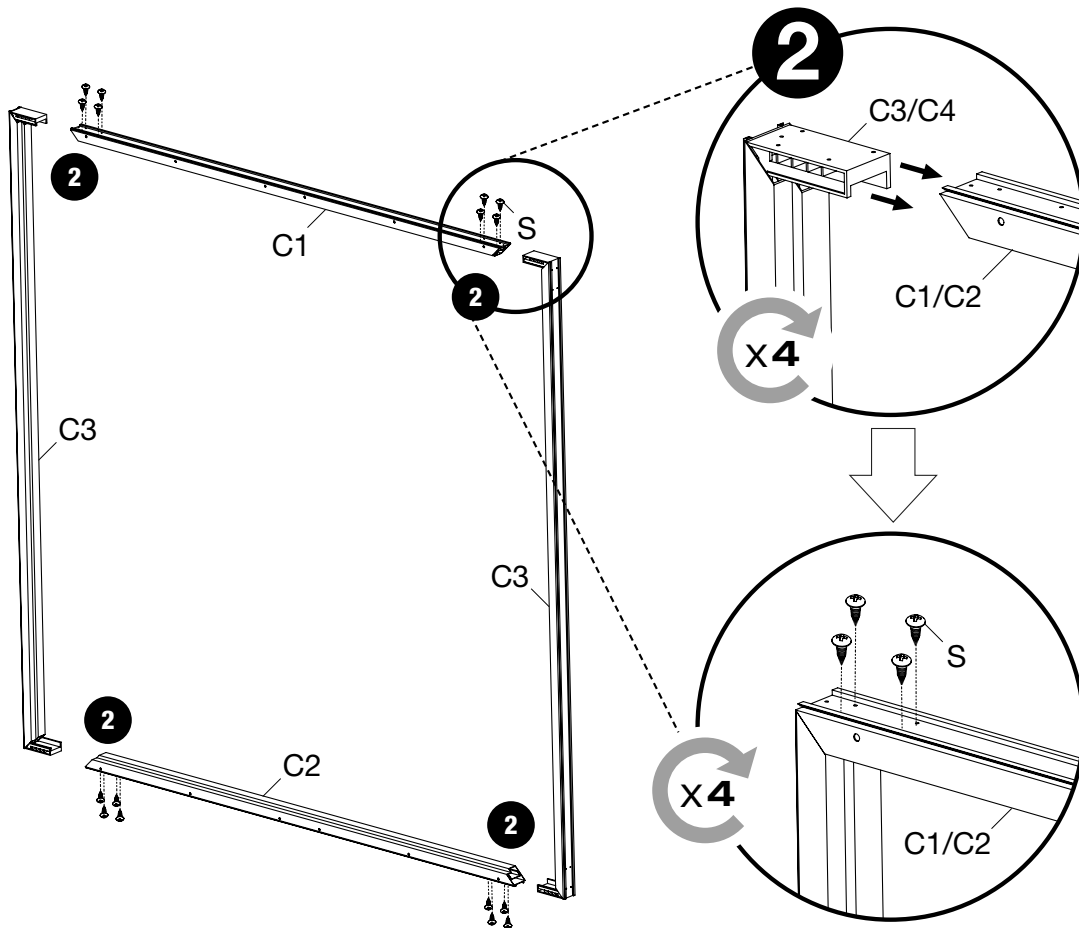
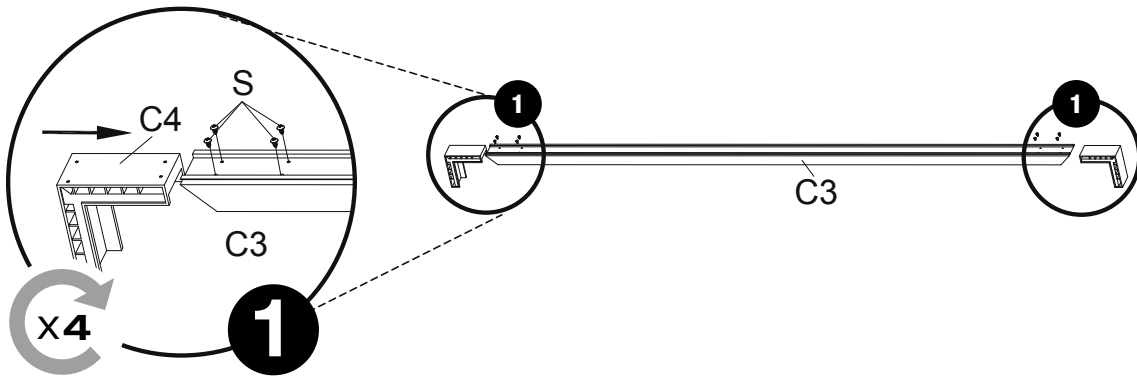

Parts list and icons for assembly:

- C1x1
- C2x1
- C3x2
- C4x4
- Sx32

Icons: 2+ people, screwdriver, and screw.

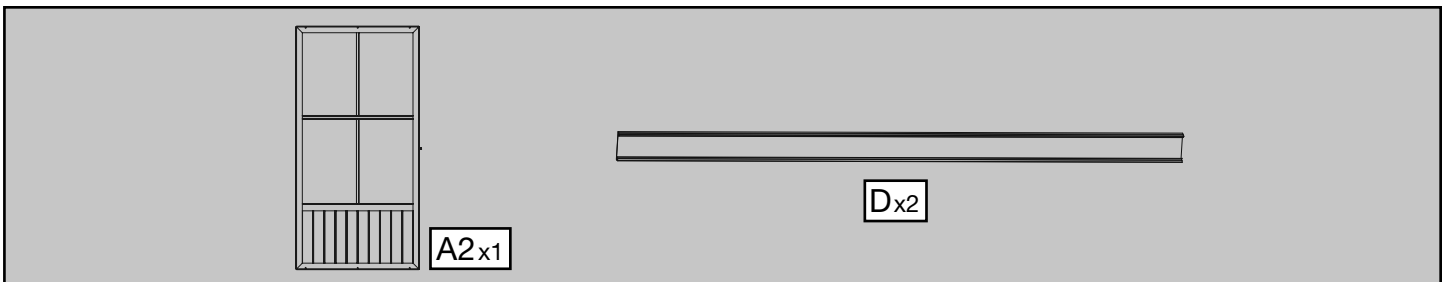
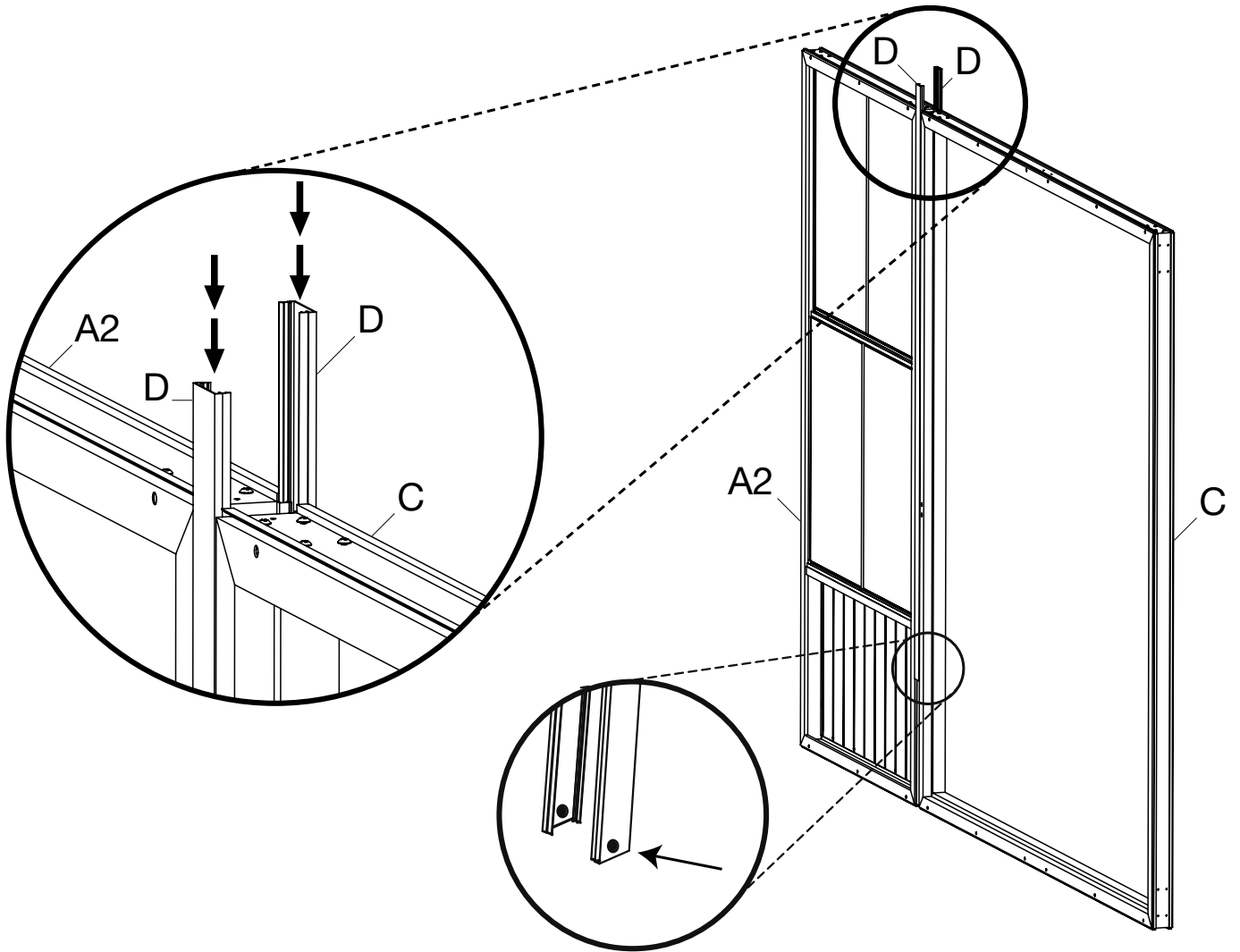

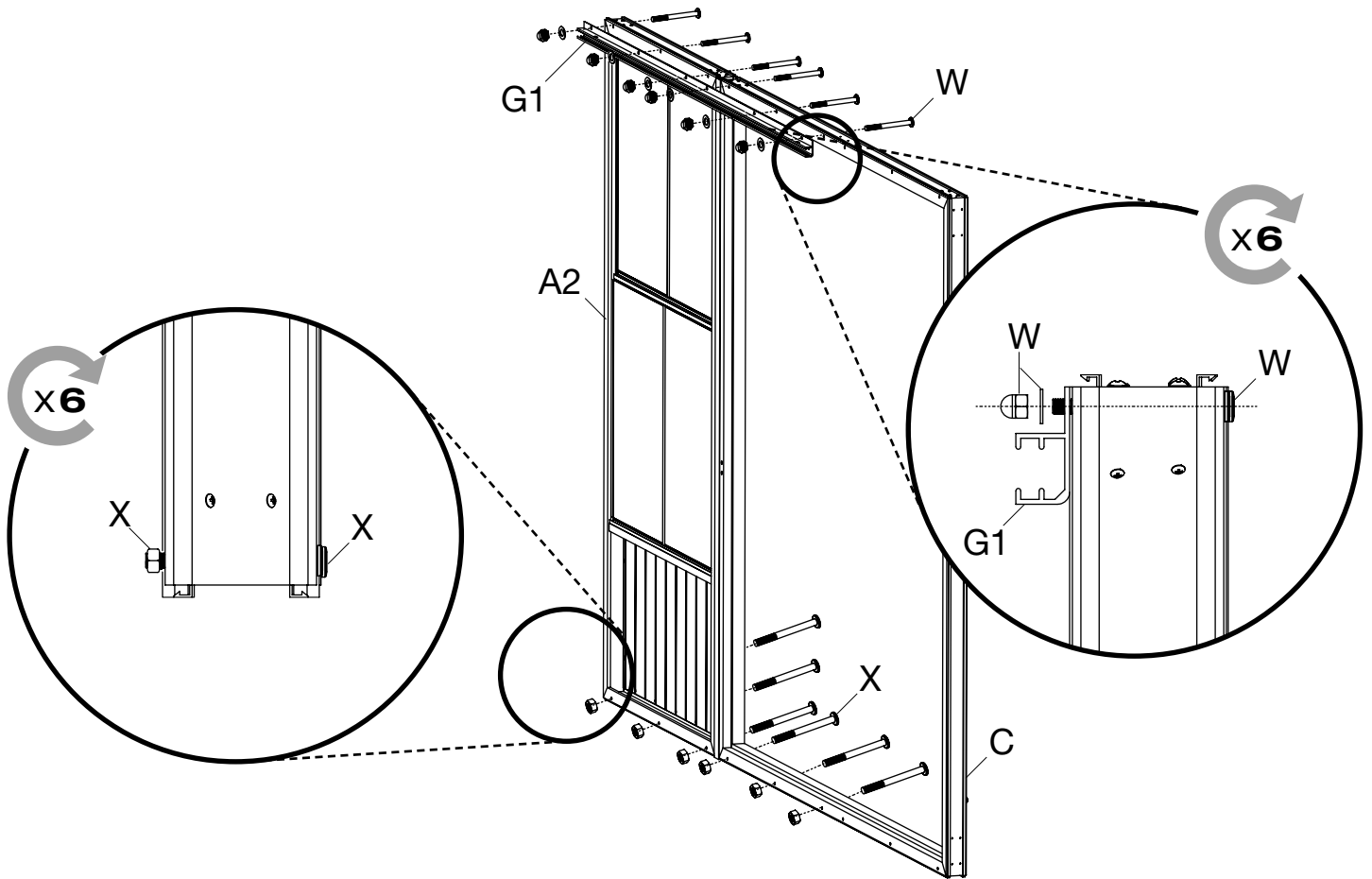

This section contains the parts list and safety instructions for the assembly step. It features a long rail labeled **G1x1**. Below it are two pins labeled **Xx6** and two washers labeled **Wx6**. To the right of the parts list are two circular icons: one with two people and the number **2+**, and another with a hand and a diagonal slash, indicating that manual force should not be used.

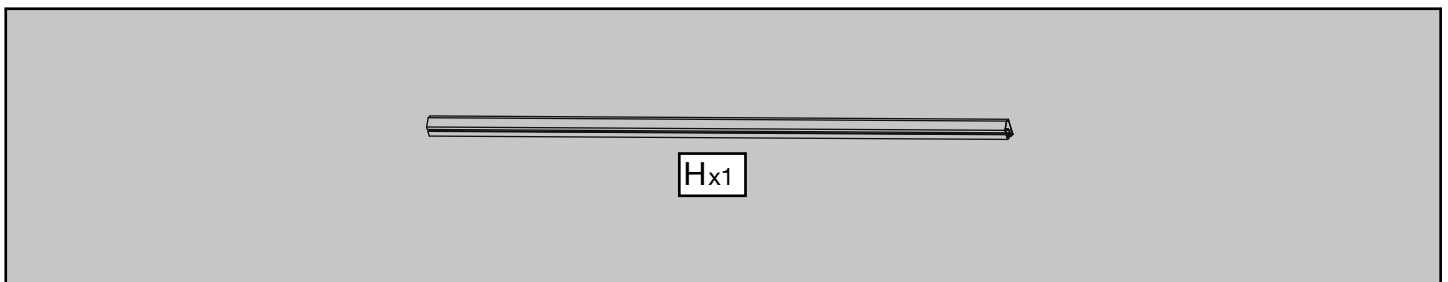
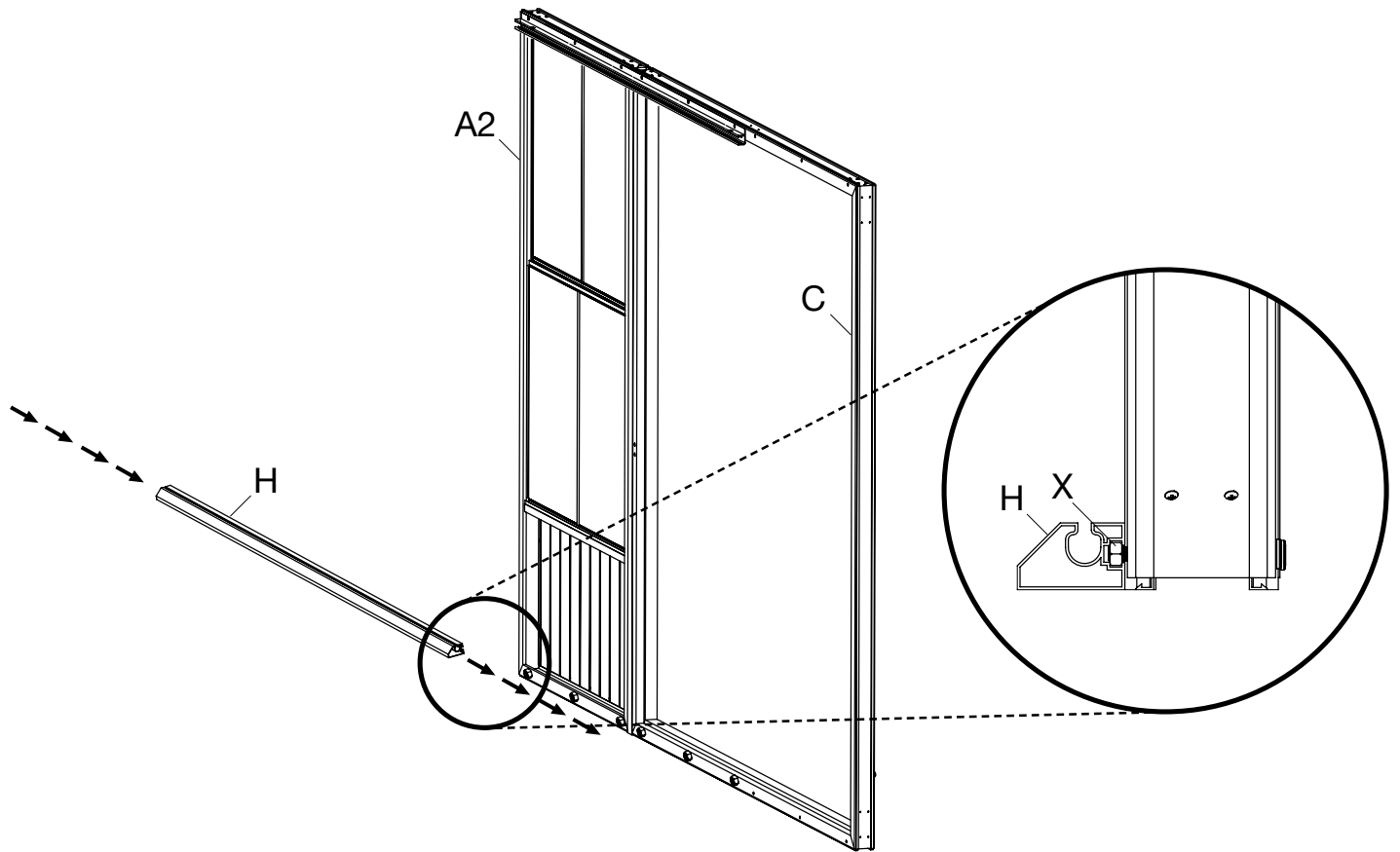

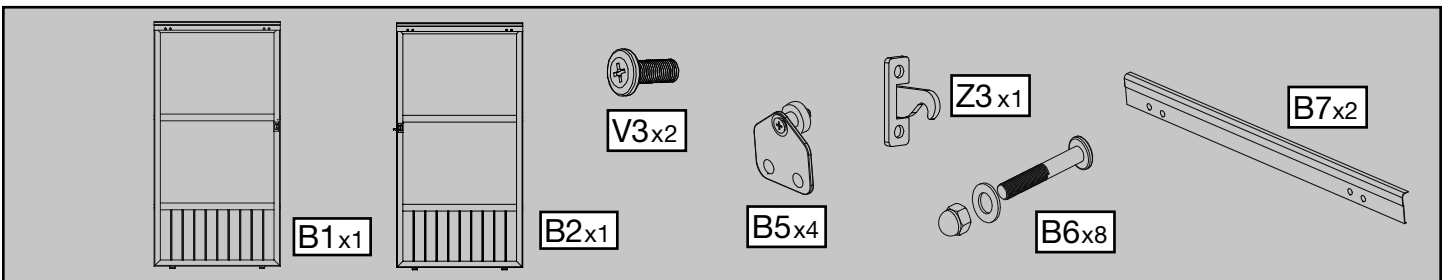
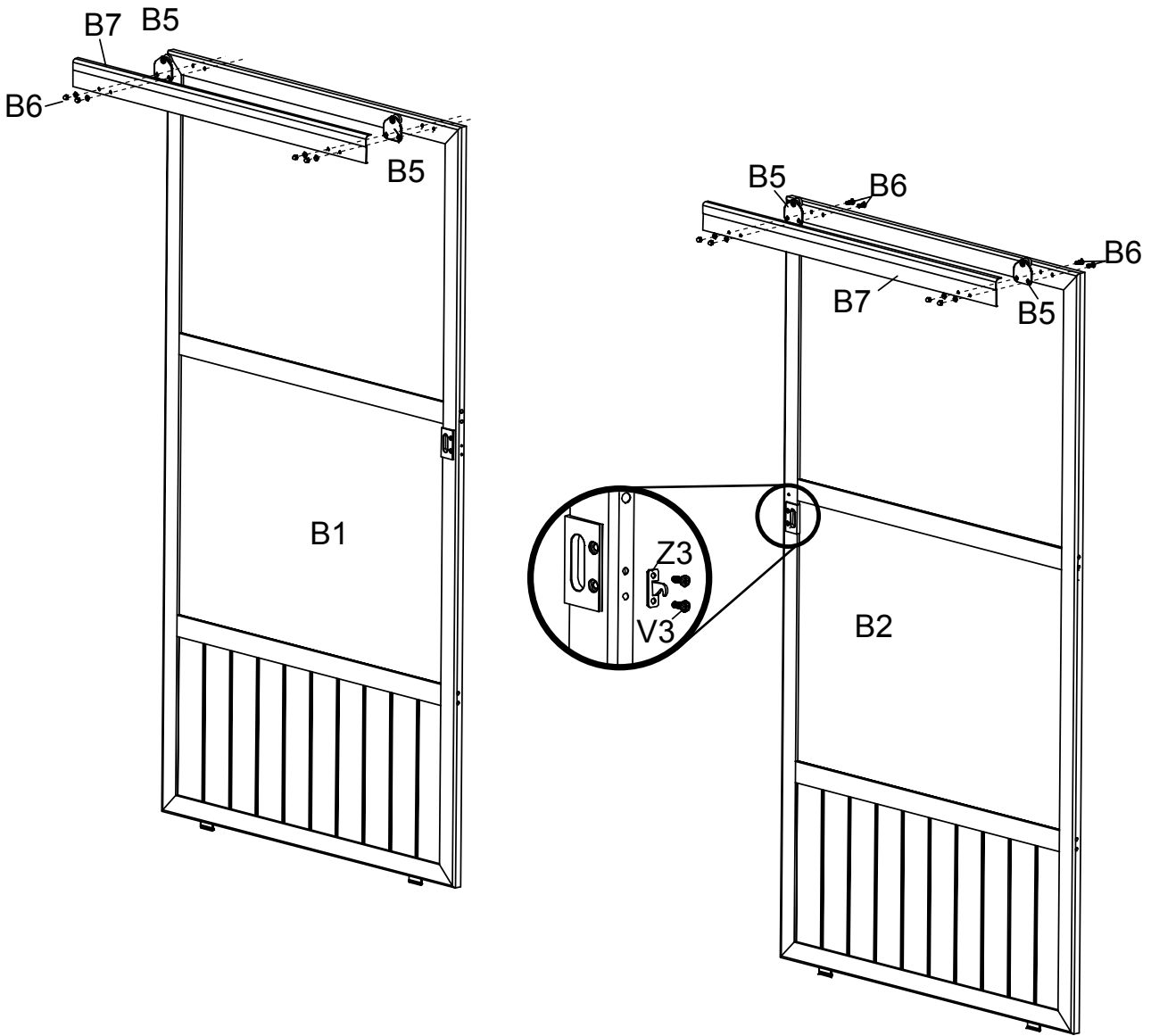

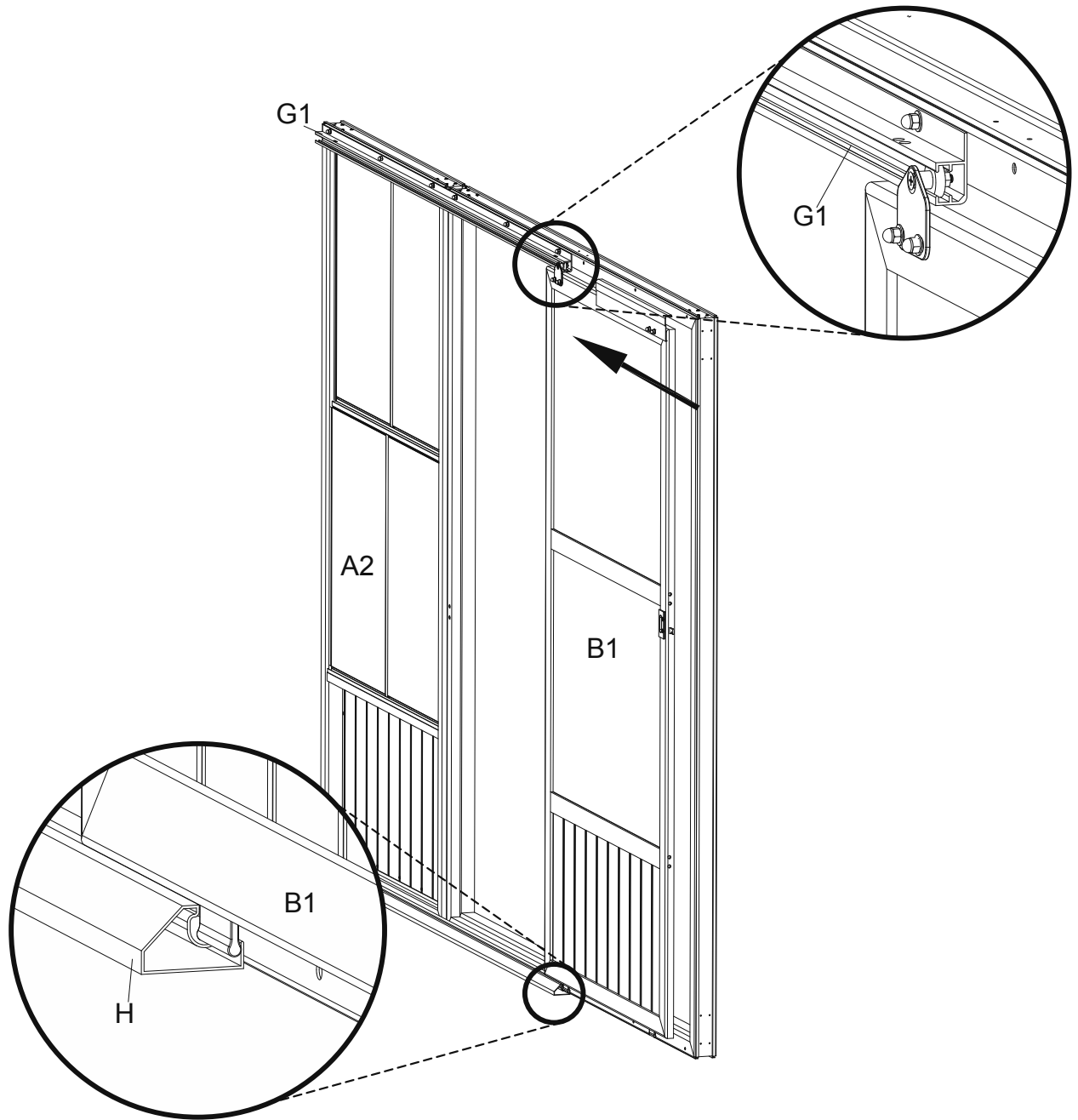

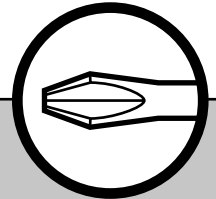
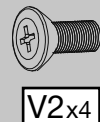
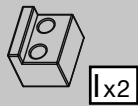
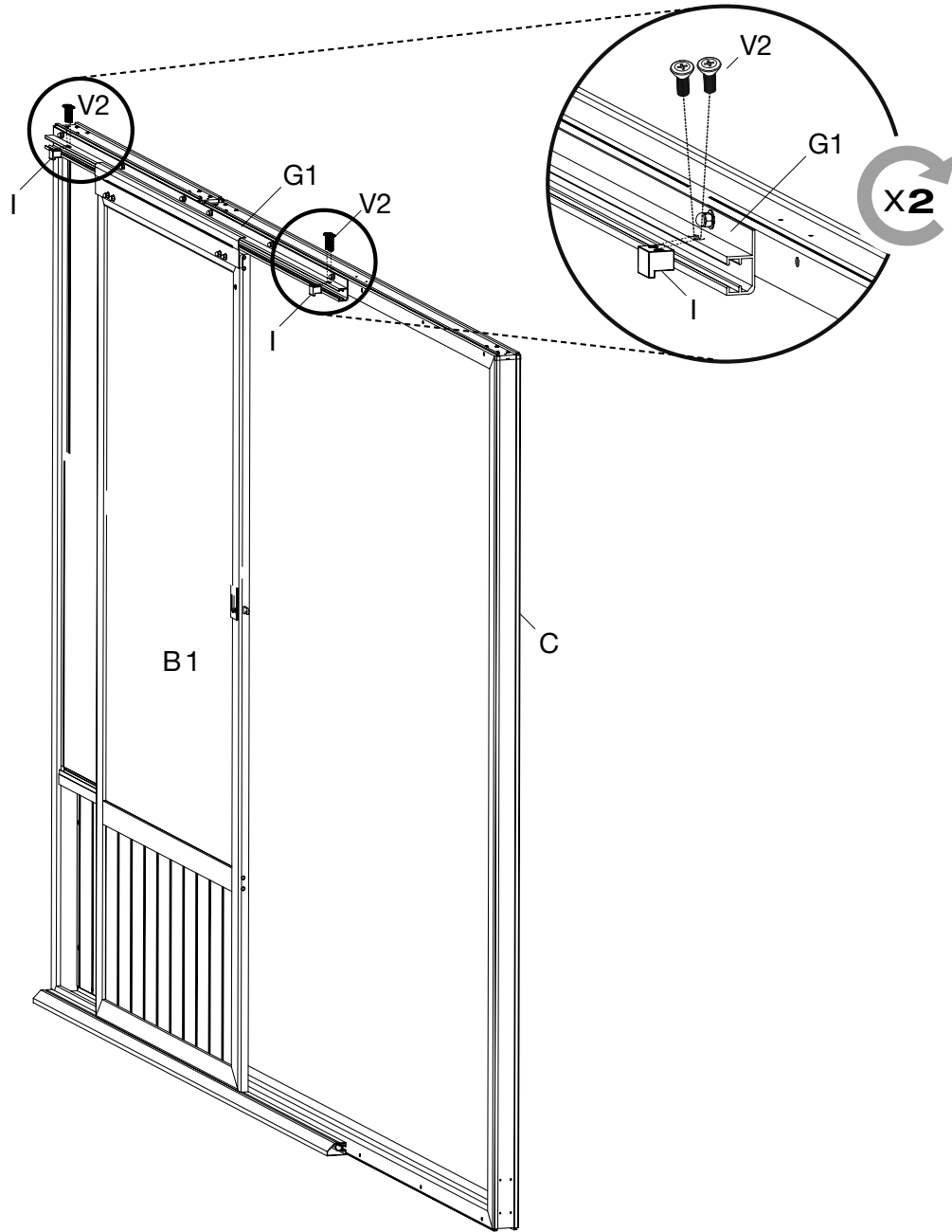

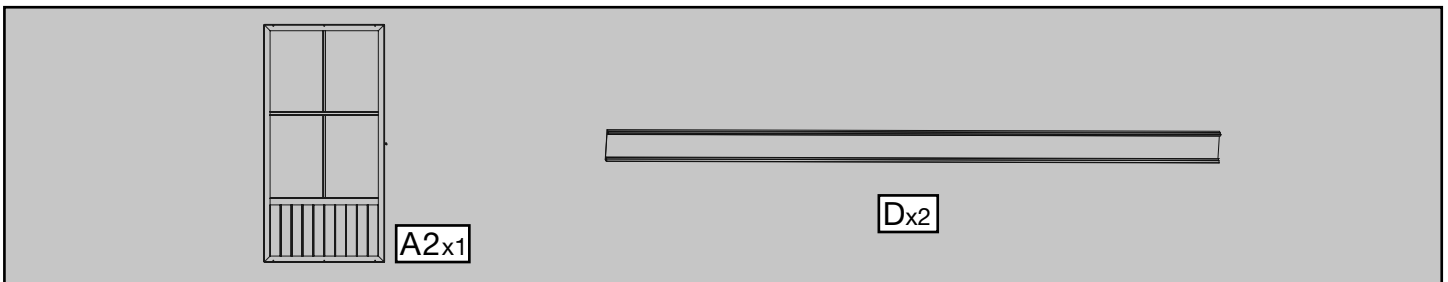
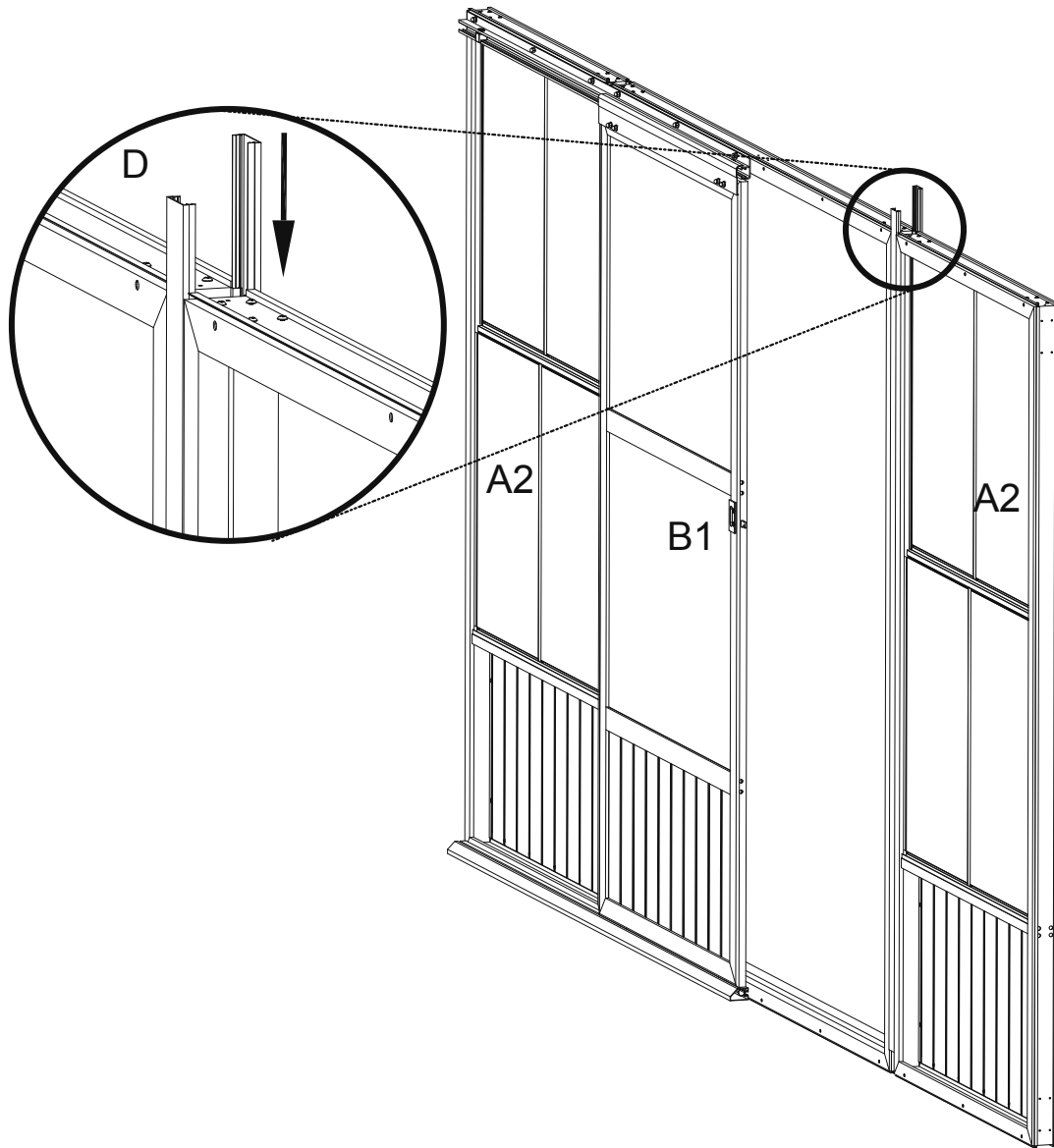

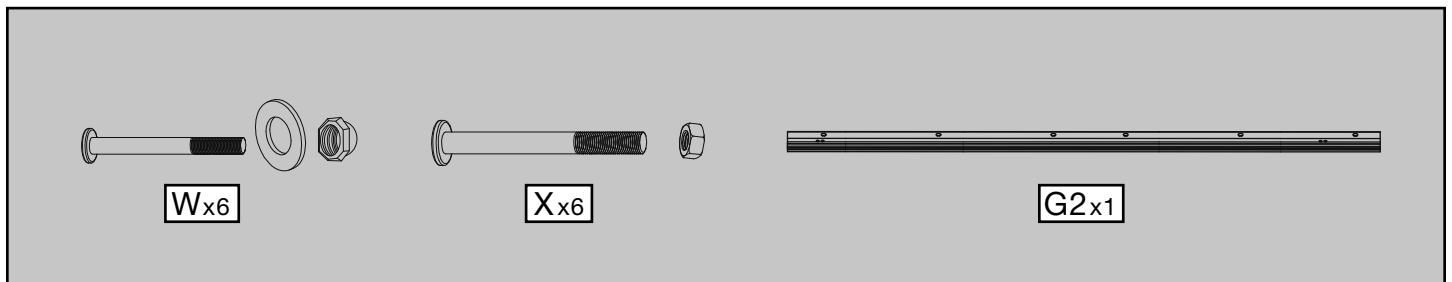
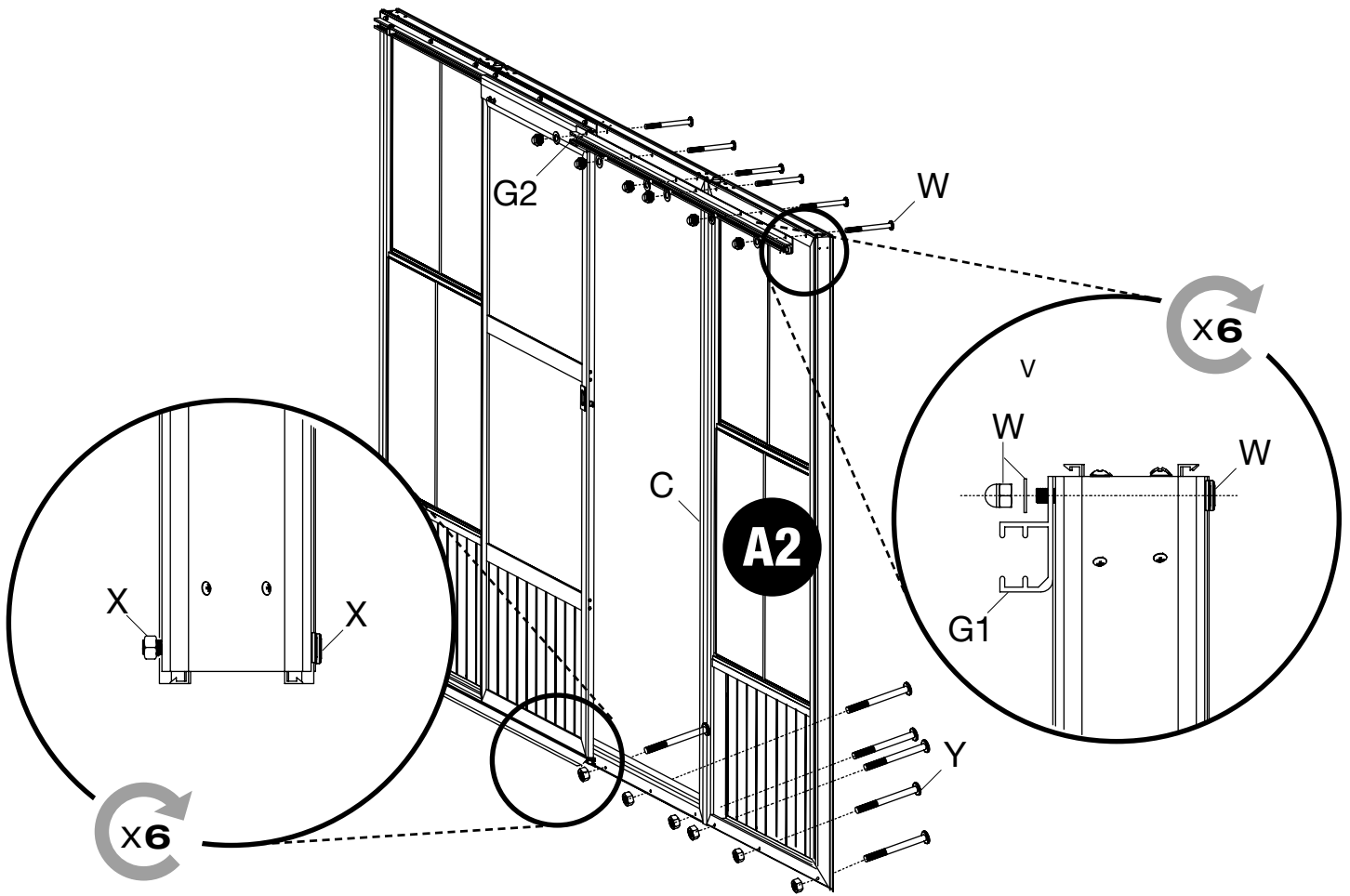

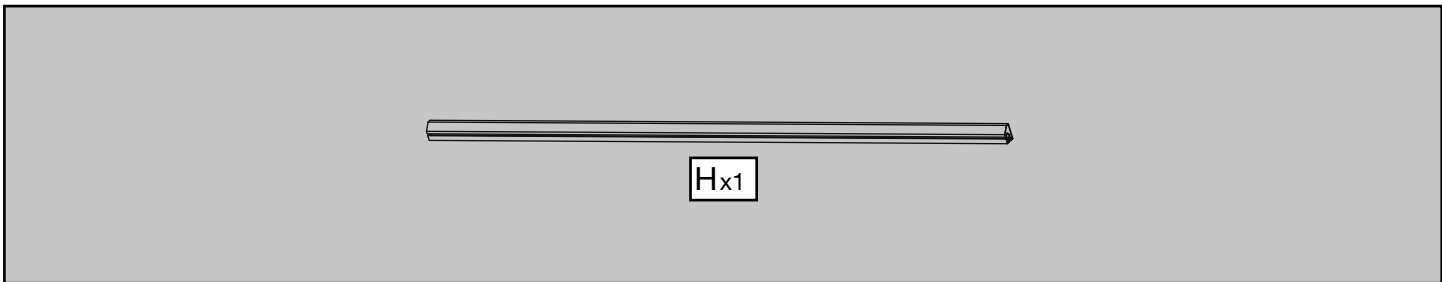
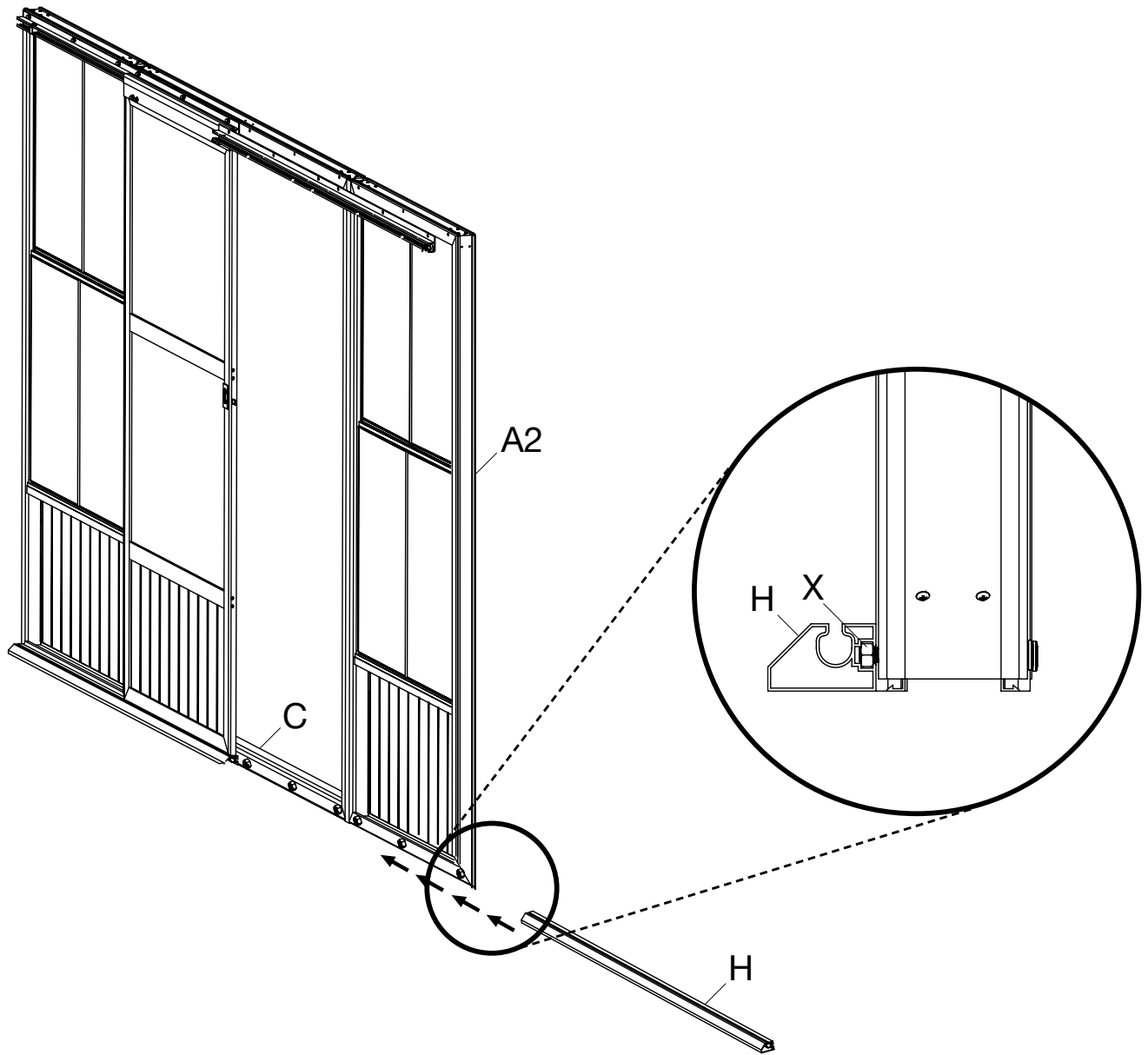

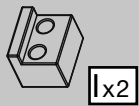
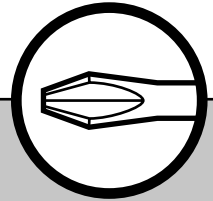
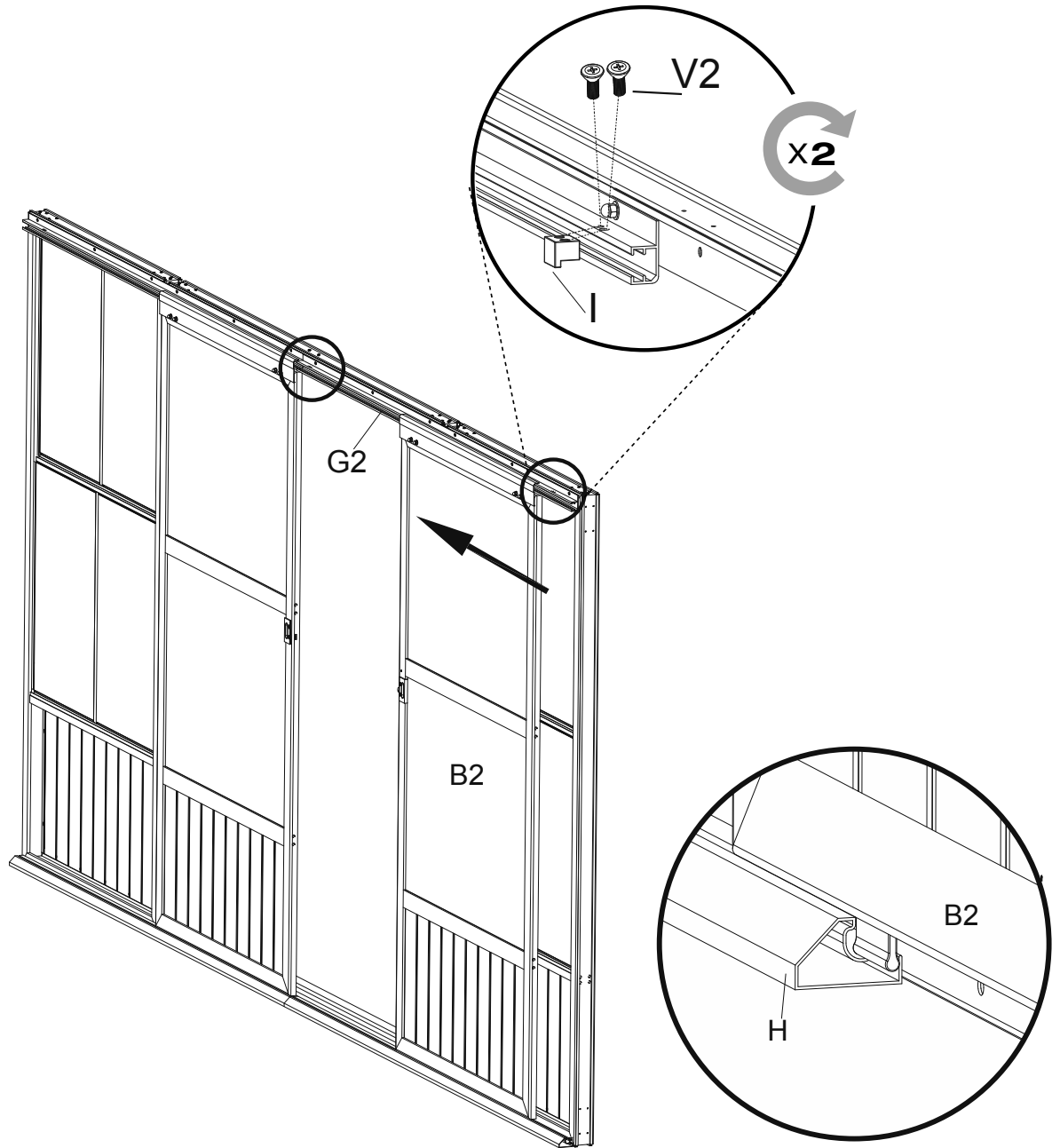

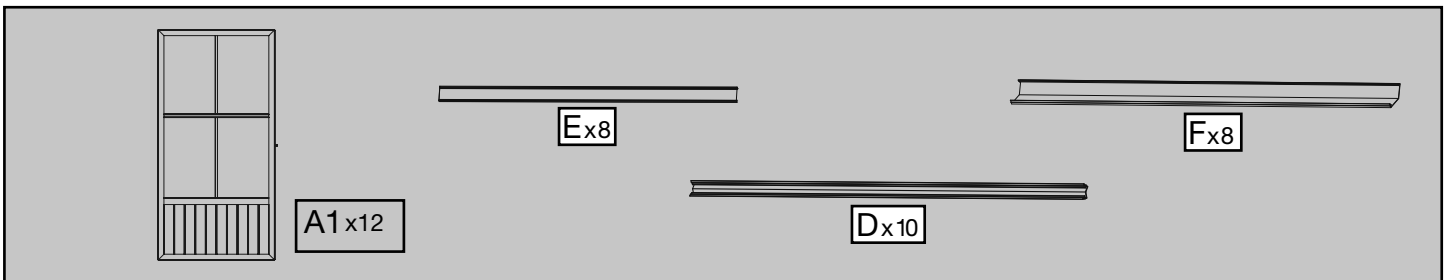
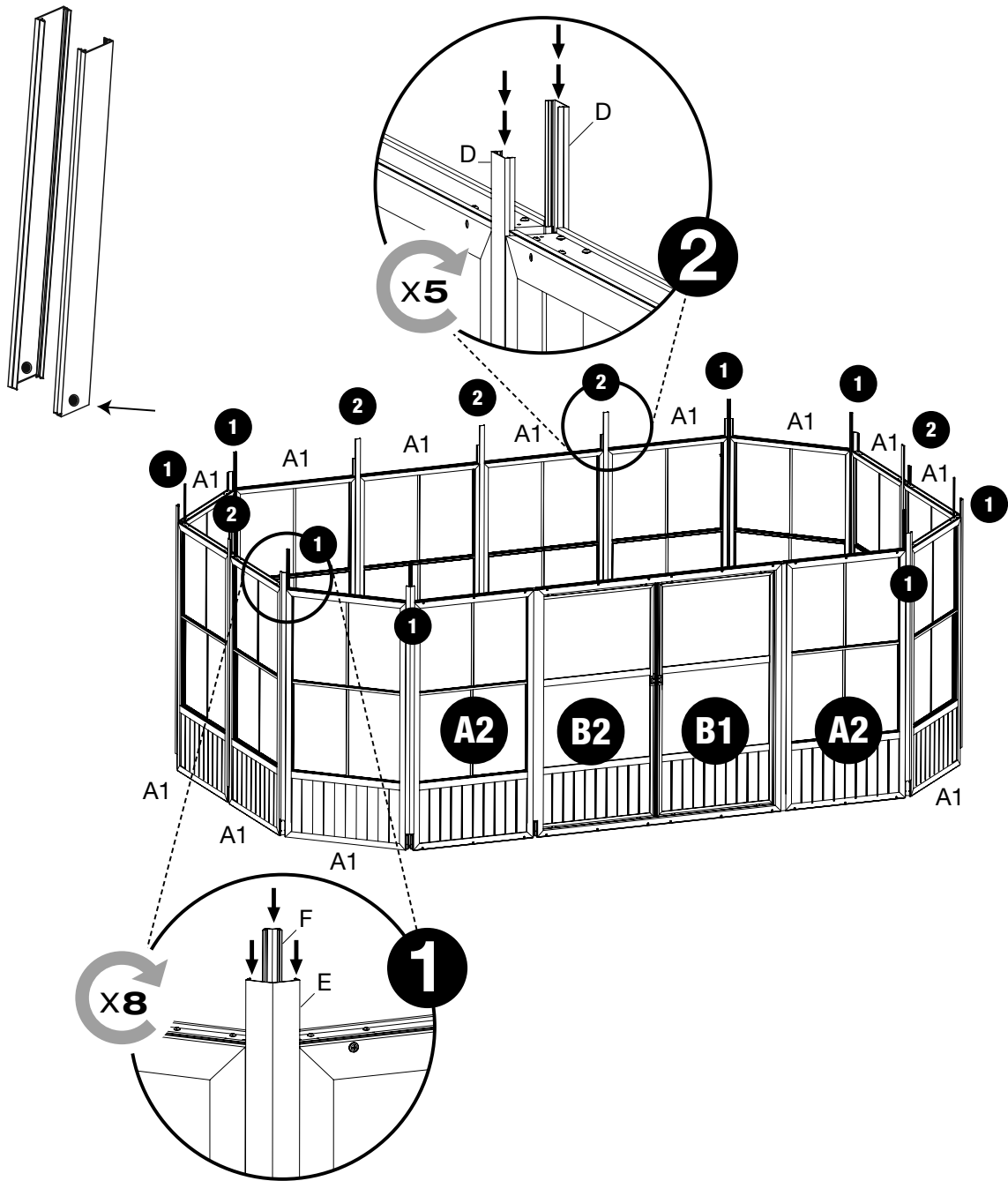

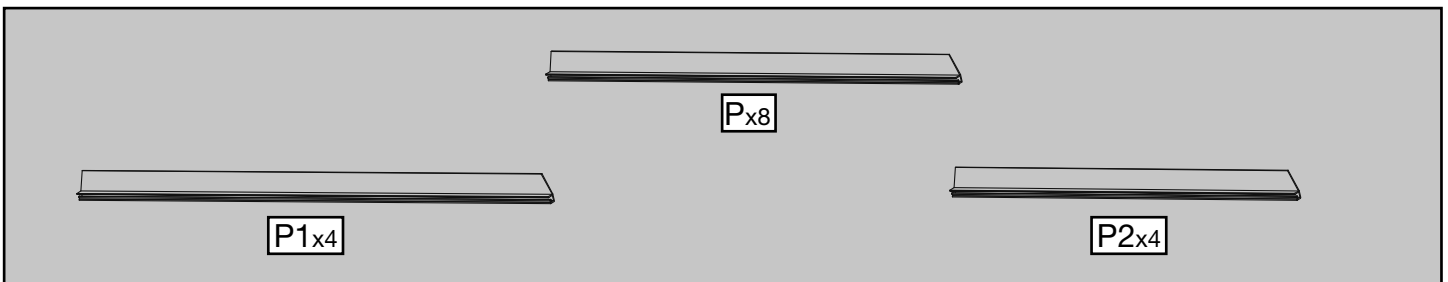
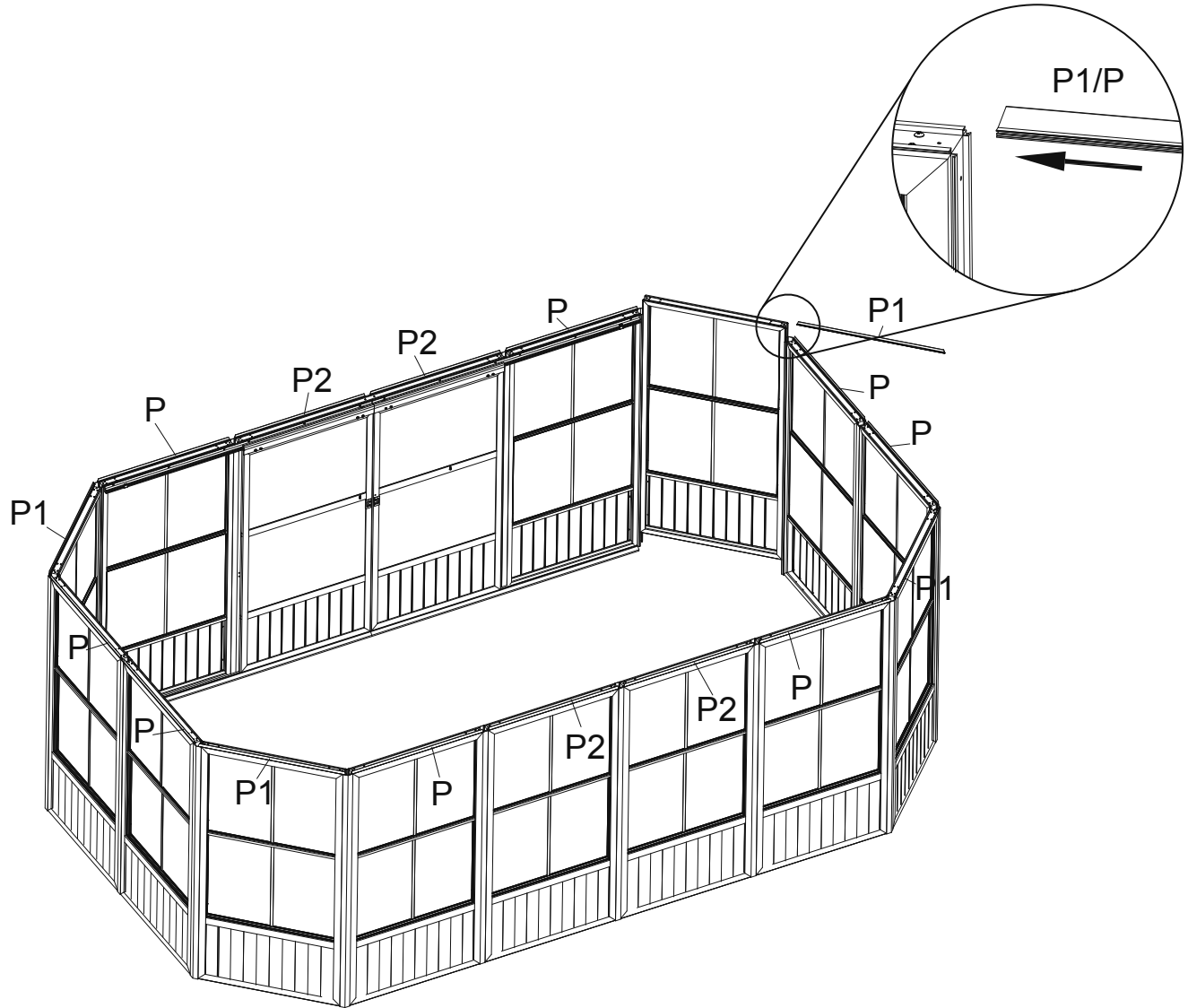



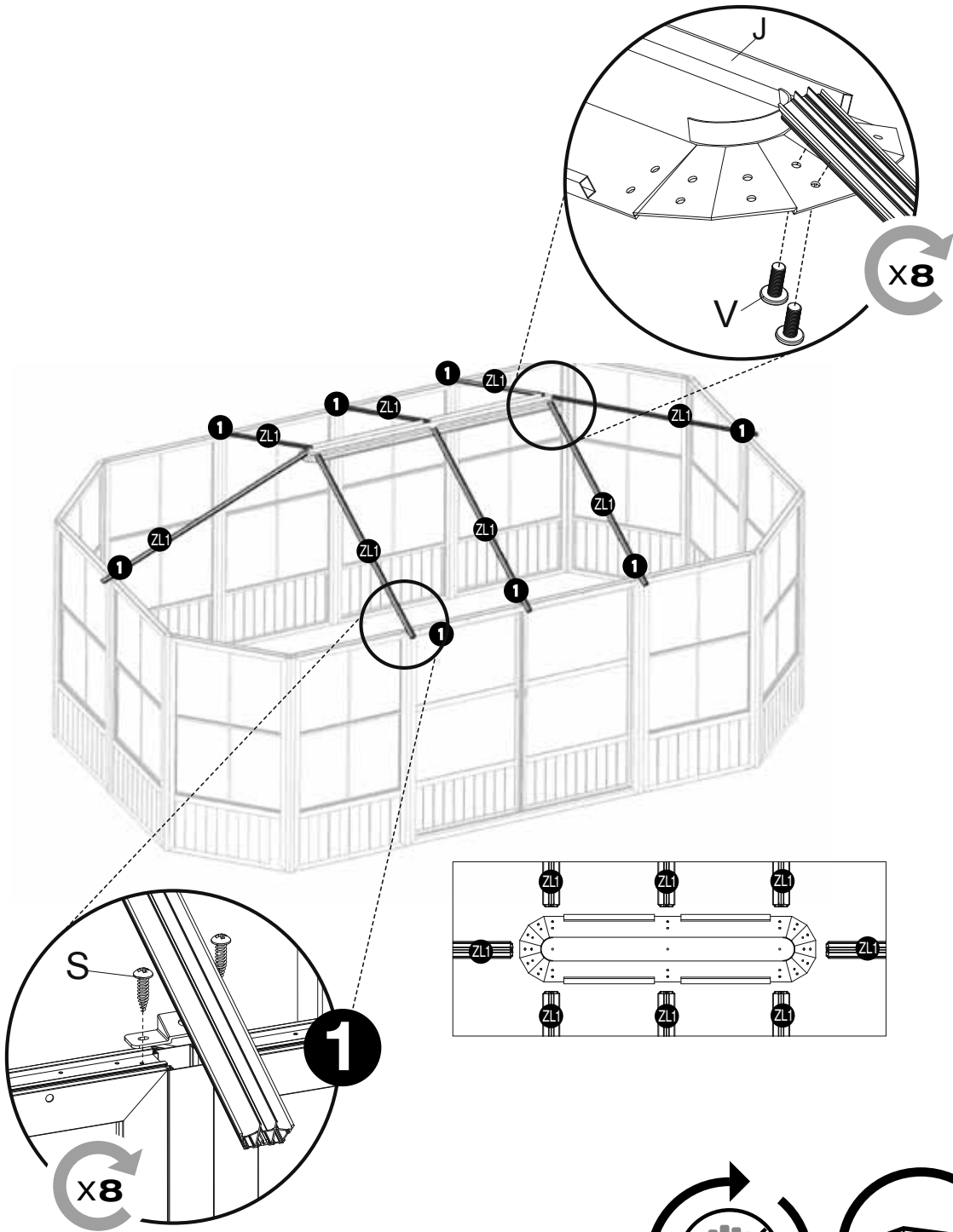

Parts list:

- J x1
- Sx16
- Vx16

Safety icons:

- No hand icon (prohibited)
- Wrench icon (required)

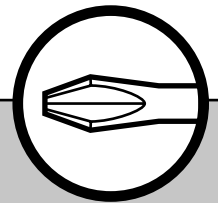
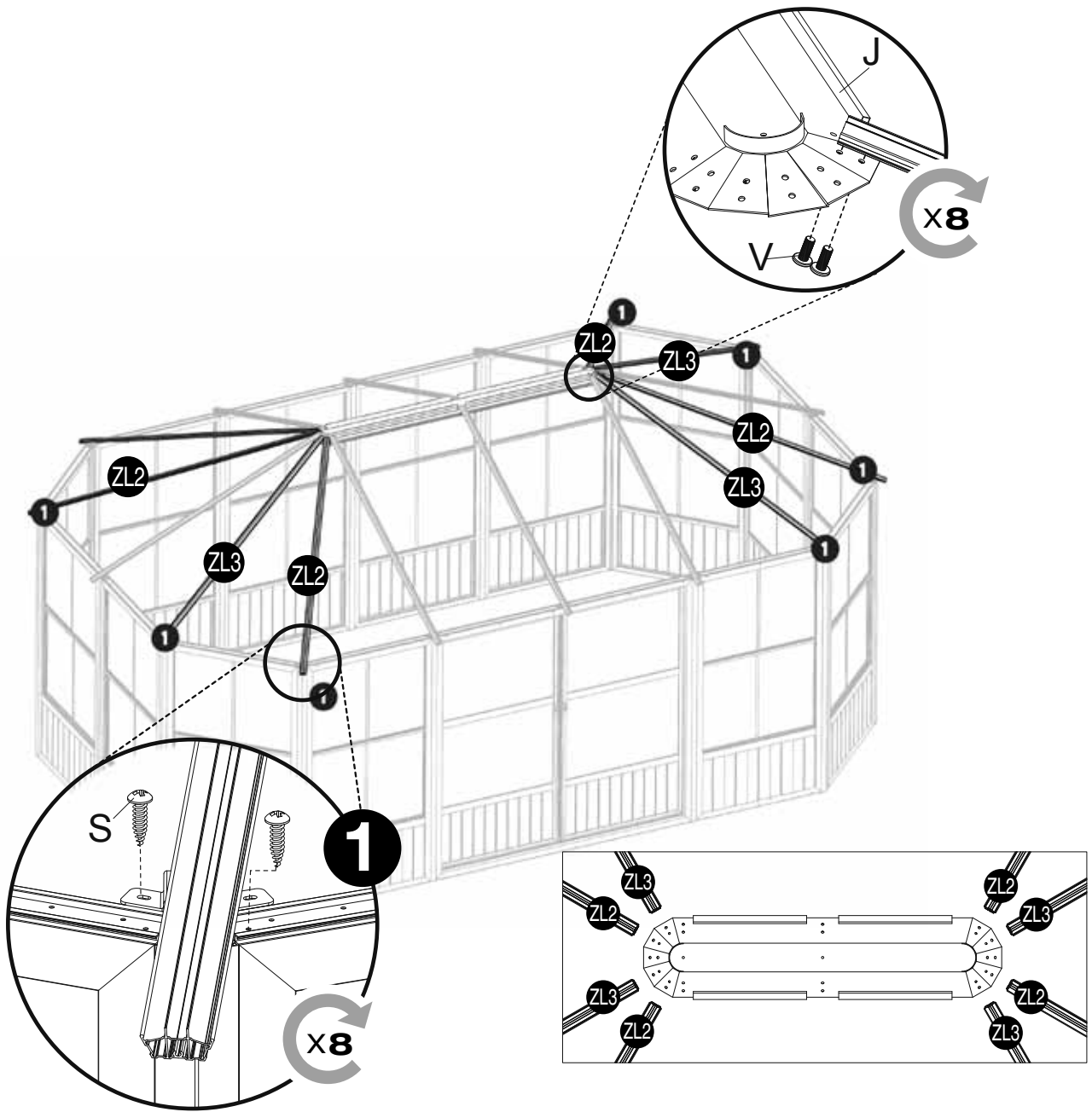

Vx16

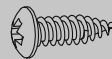

Sx16

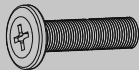
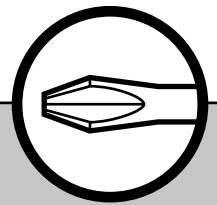
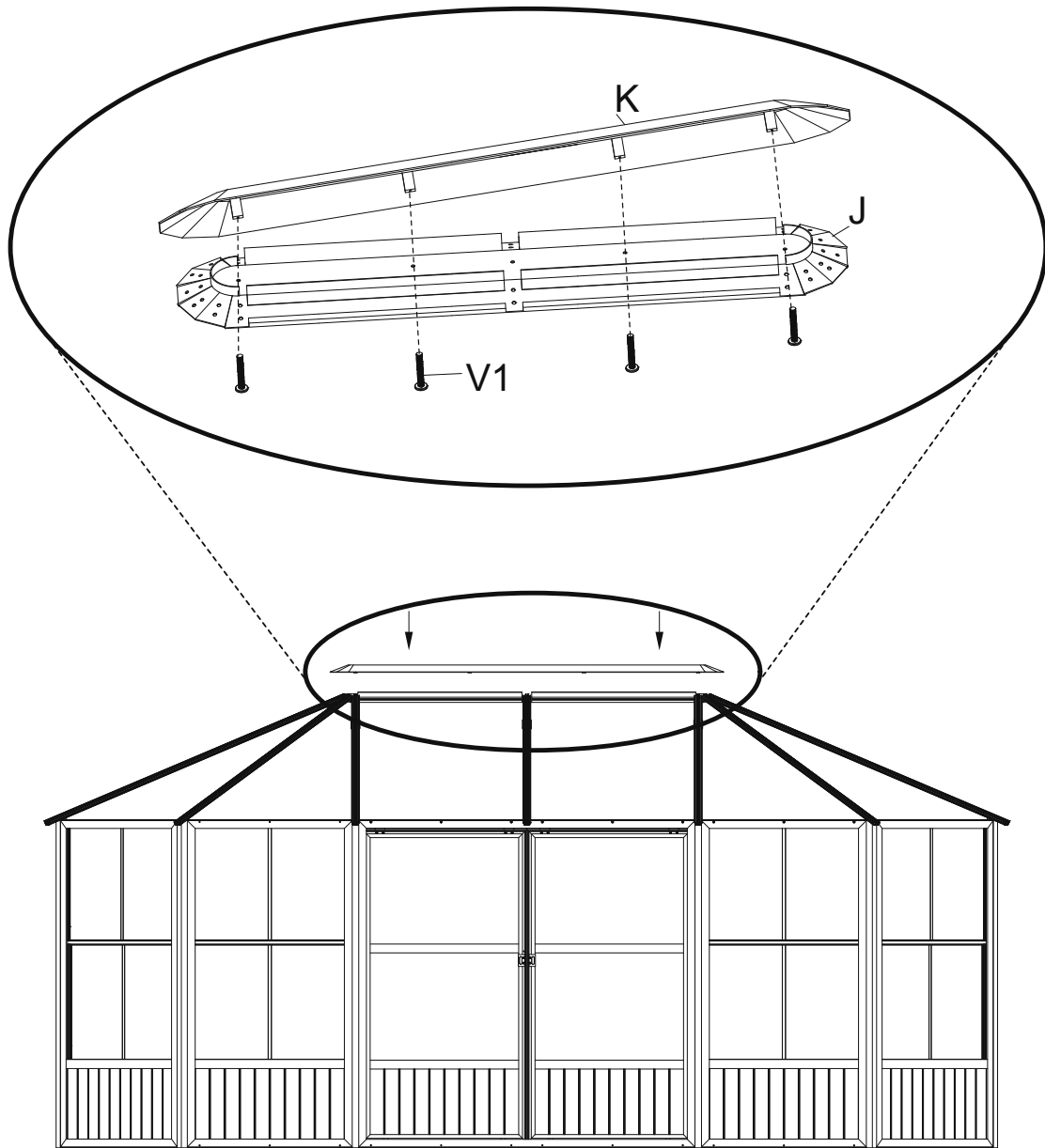

V1x4

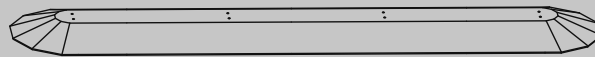

Kx1

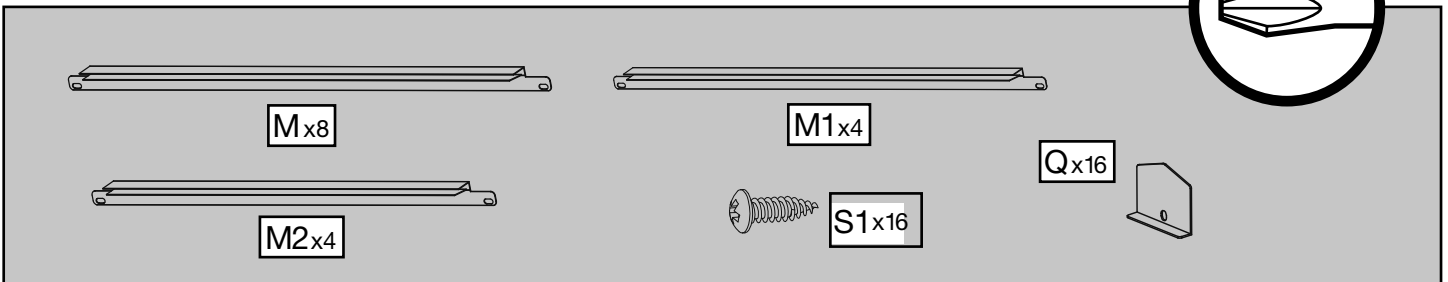
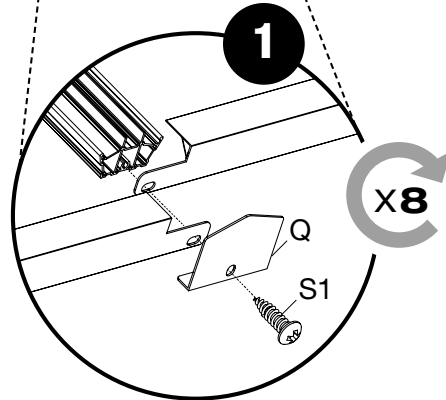
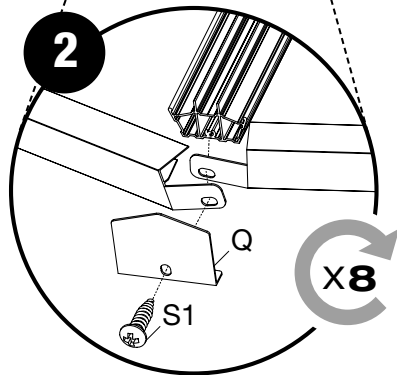
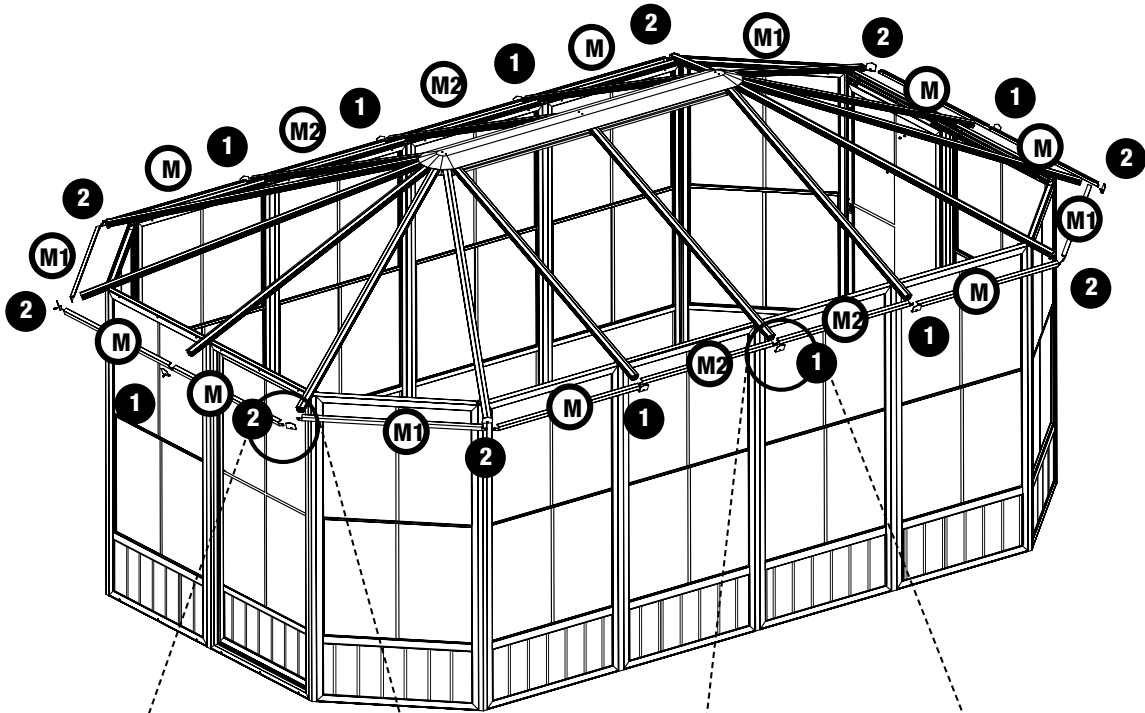
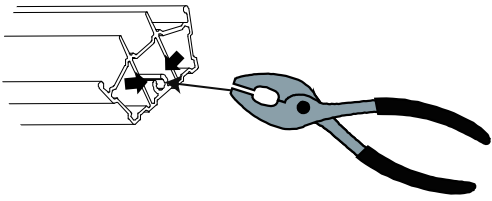

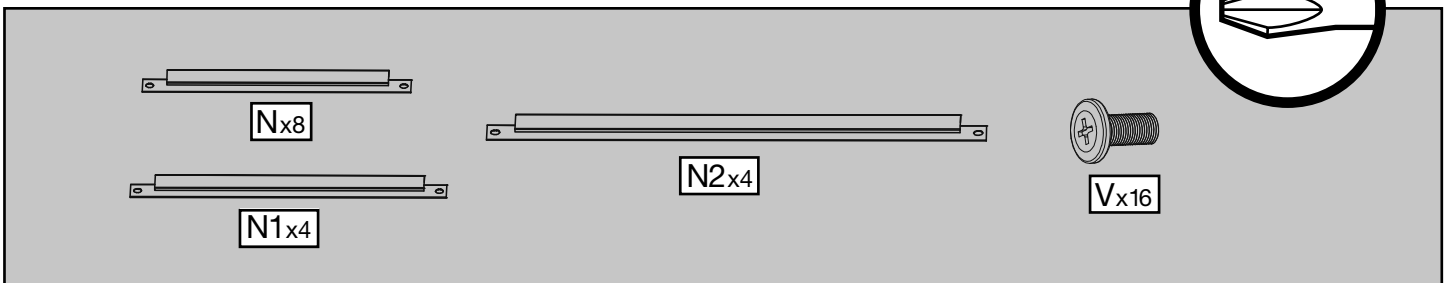
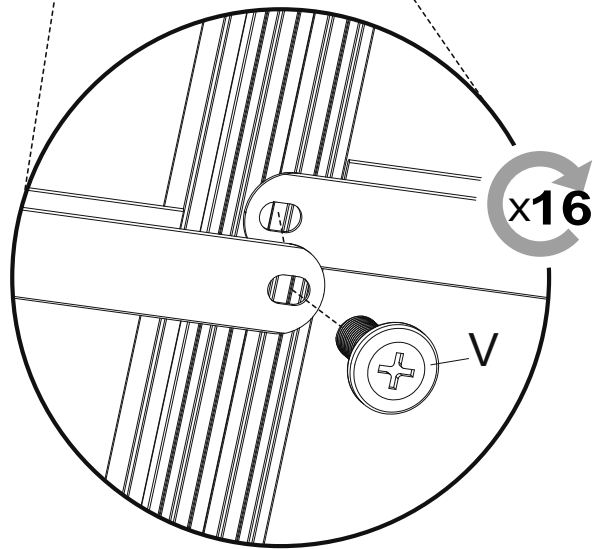
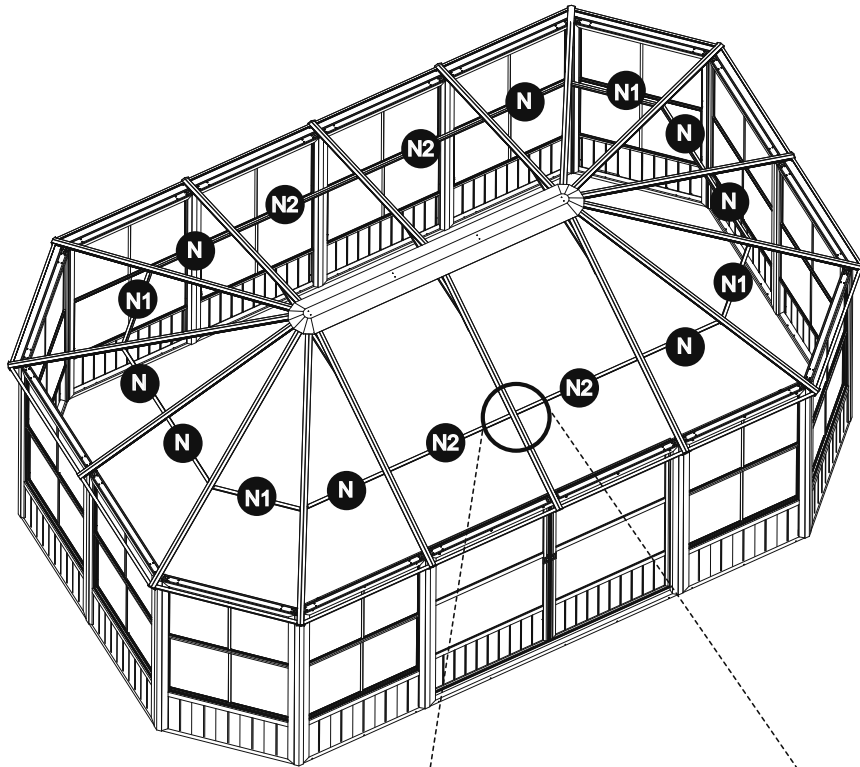

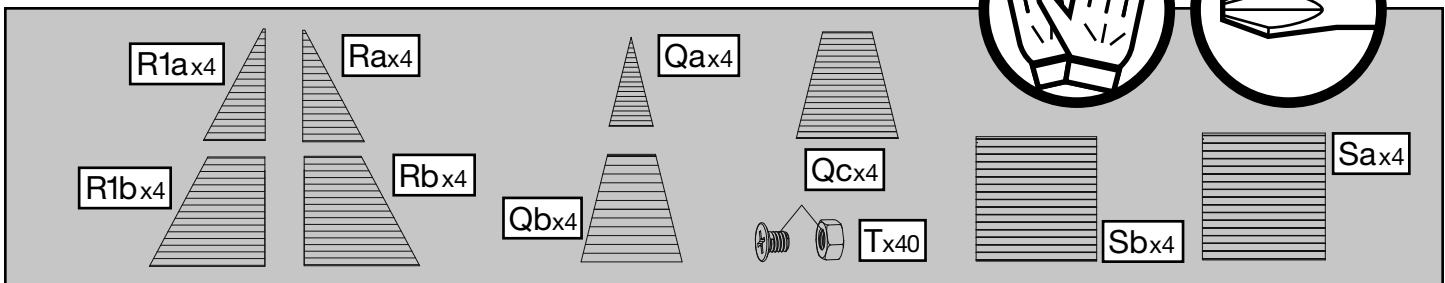
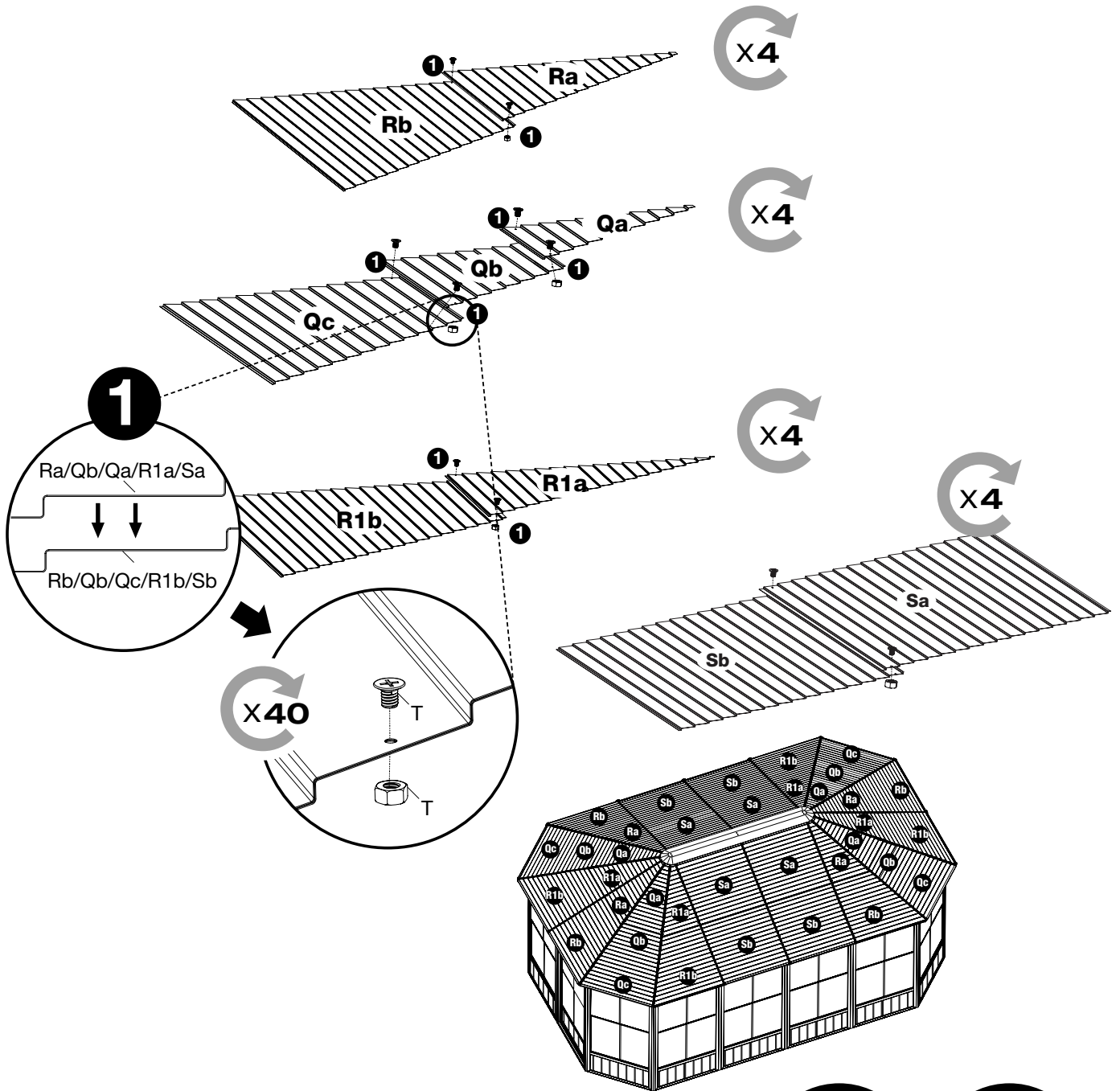

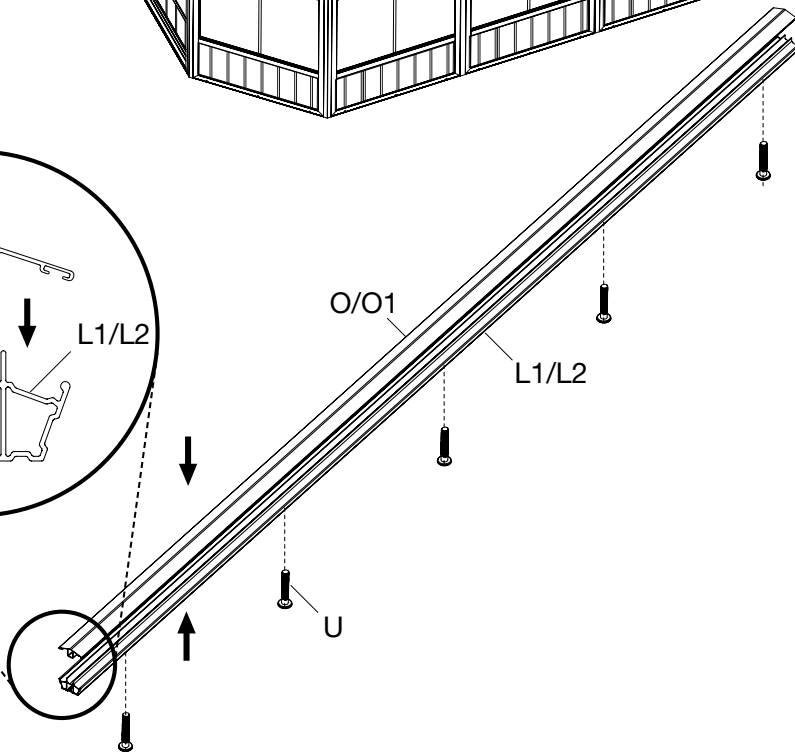
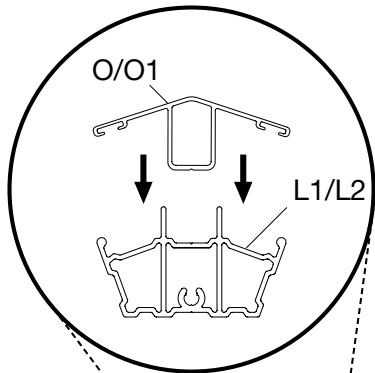
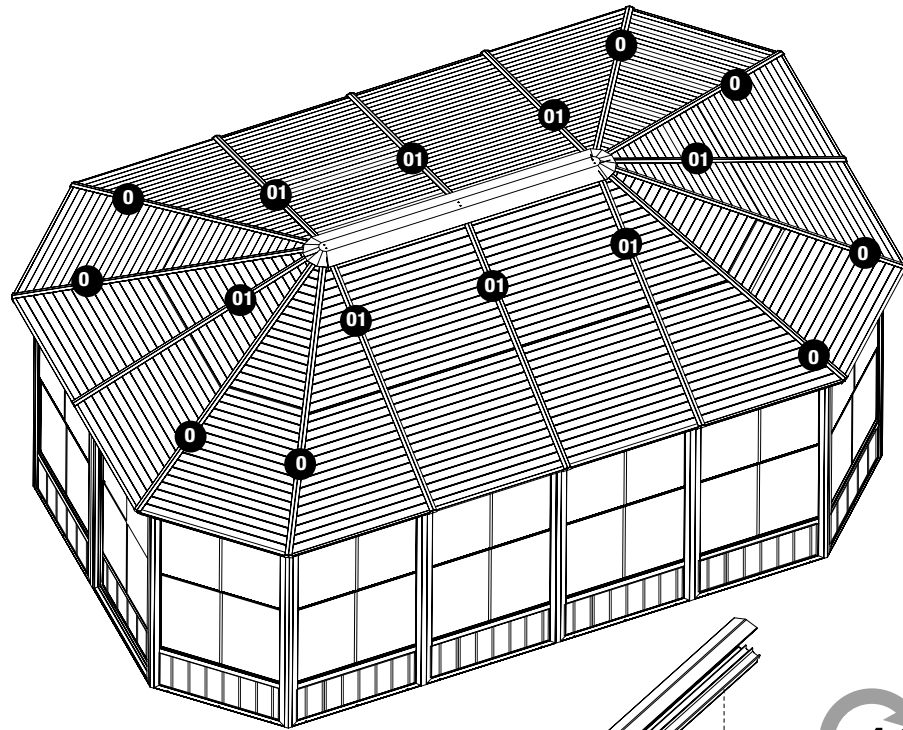

x16

