

SCANDI 2FBAL-RECR

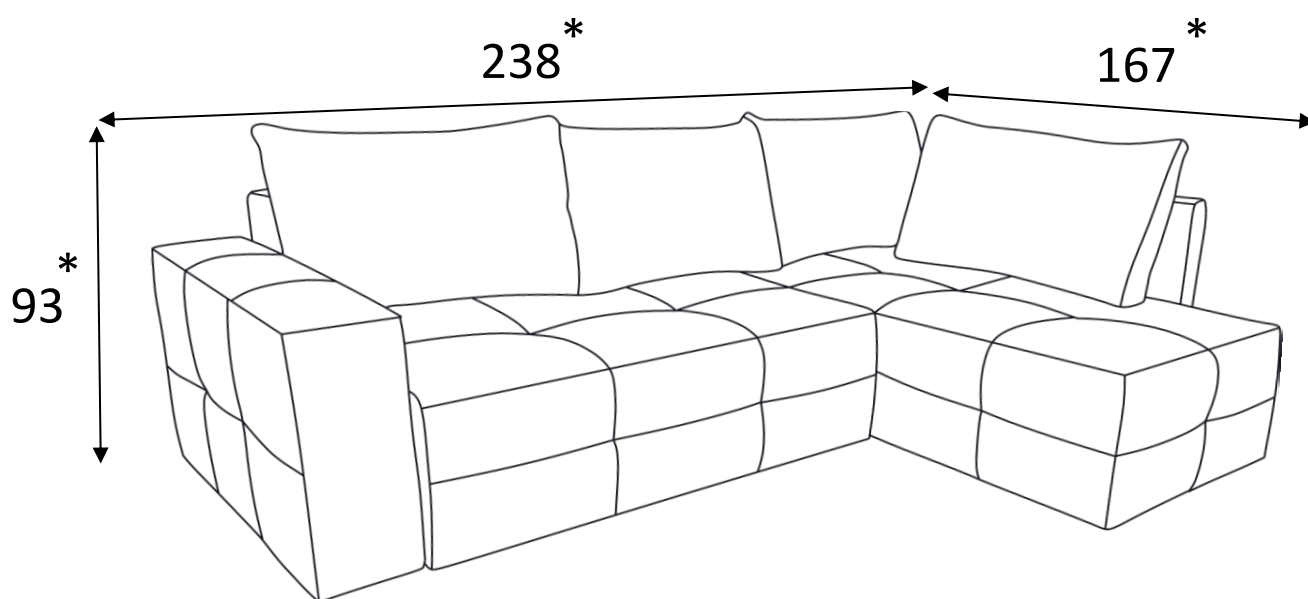

* +/- 4 cm



D – Montageanleitung
GB – Assembly instructions
NL – Handleiding voor de montage
PL – Instrukcja montażu
TR – Montaj talimatı
RU – Инструкция по монтажу

RO – Instrucțiuni de montaj
IT – Istruzioni di montaggio
FR – Notice de montage
SK – Návod na montáž
CZ – Montážní návod
HU – Szerelési útmutató

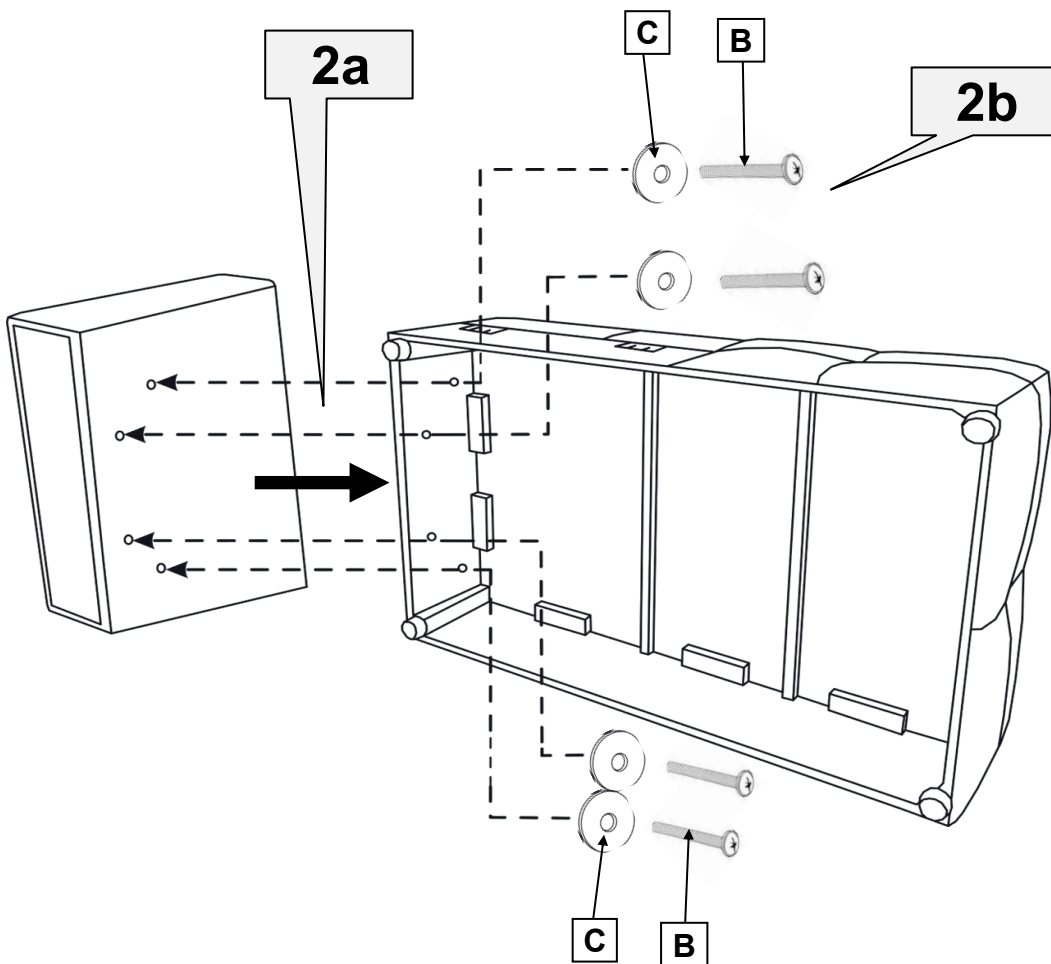
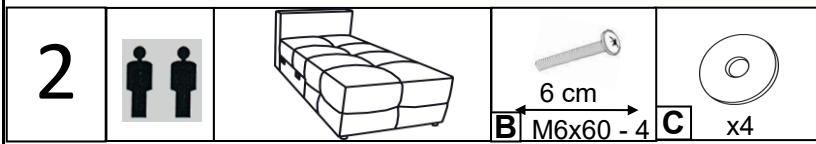
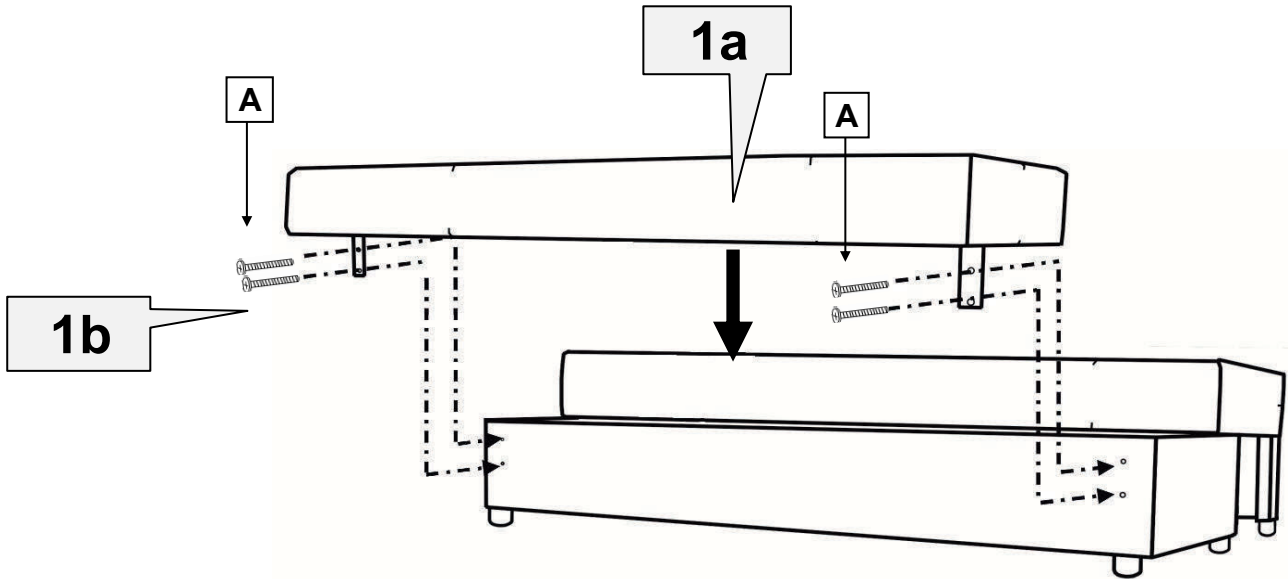
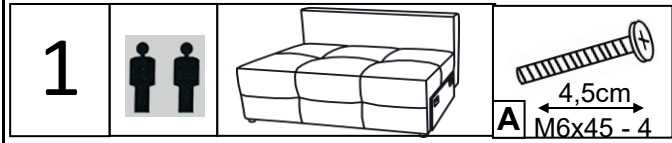
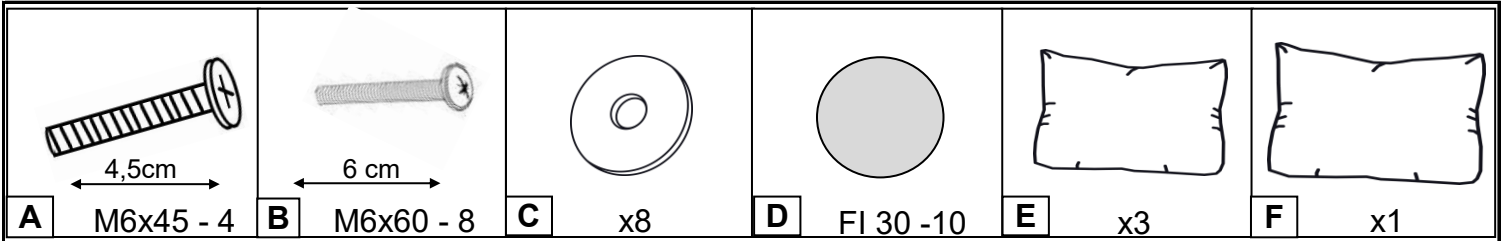

3			 6 cm B M6x60 - 4	 D x4	 E FI 30 -10
---	--	--	-------------------------	----------	-----------------

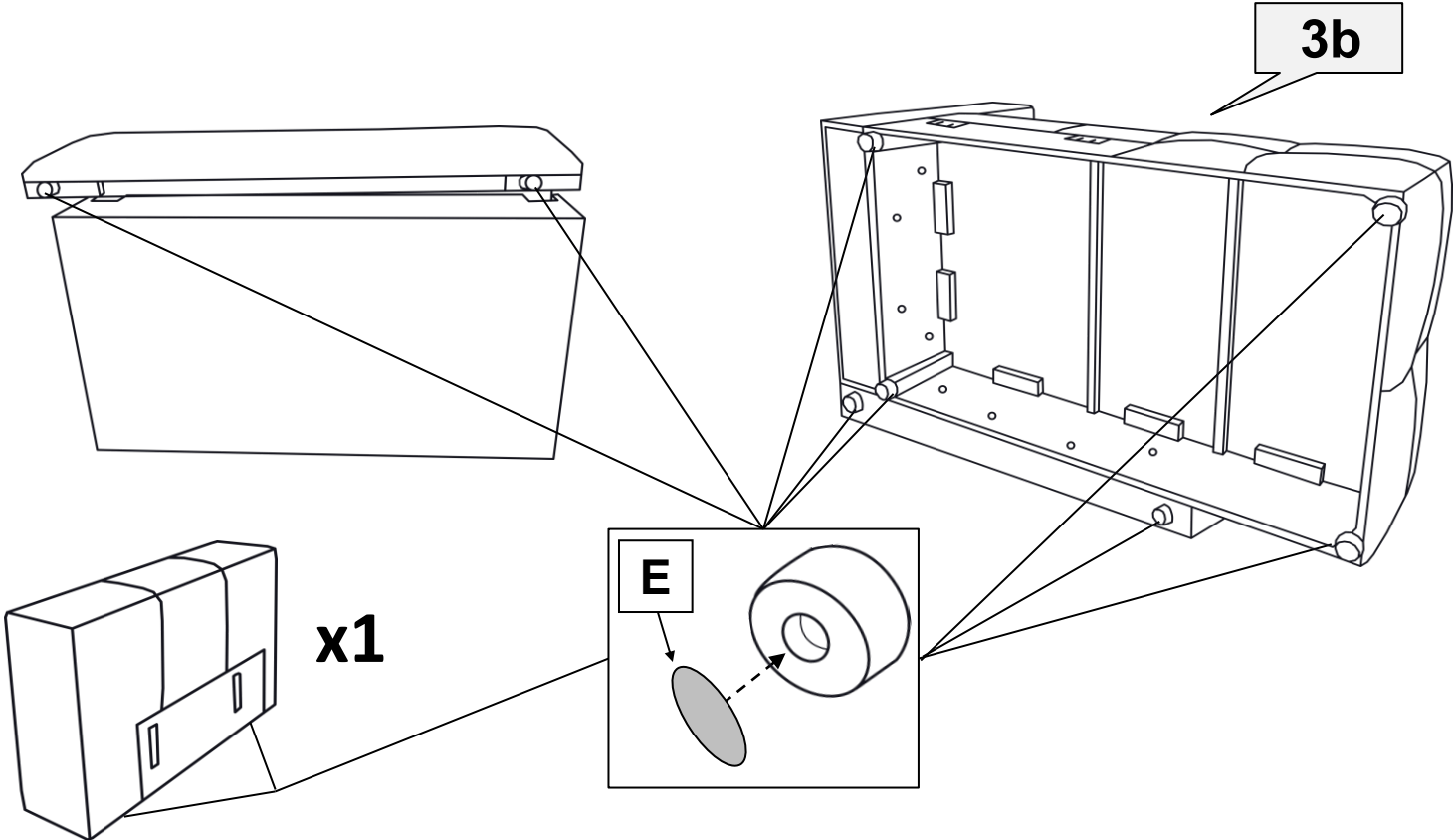
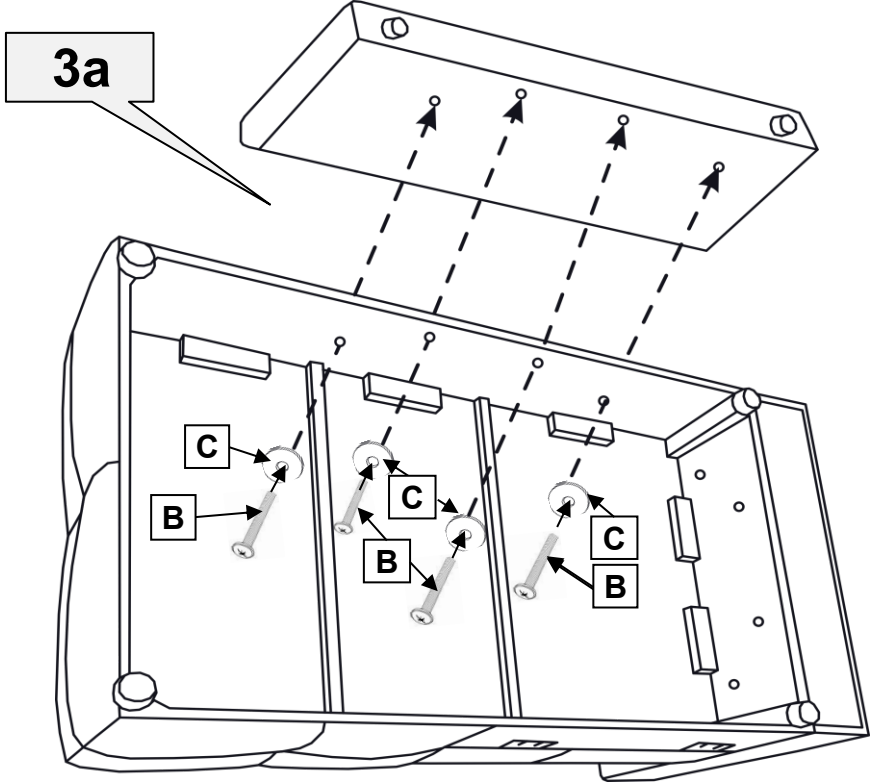

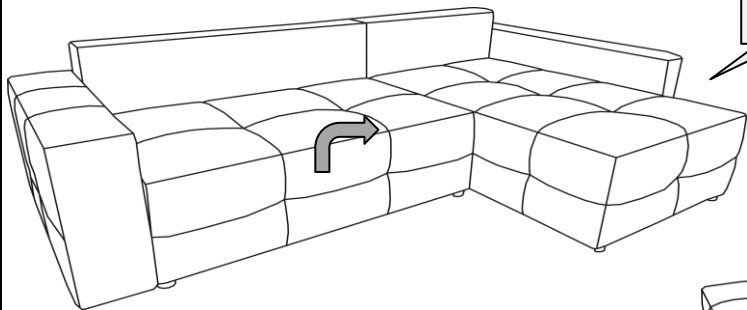
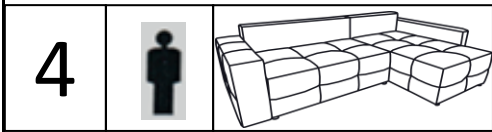
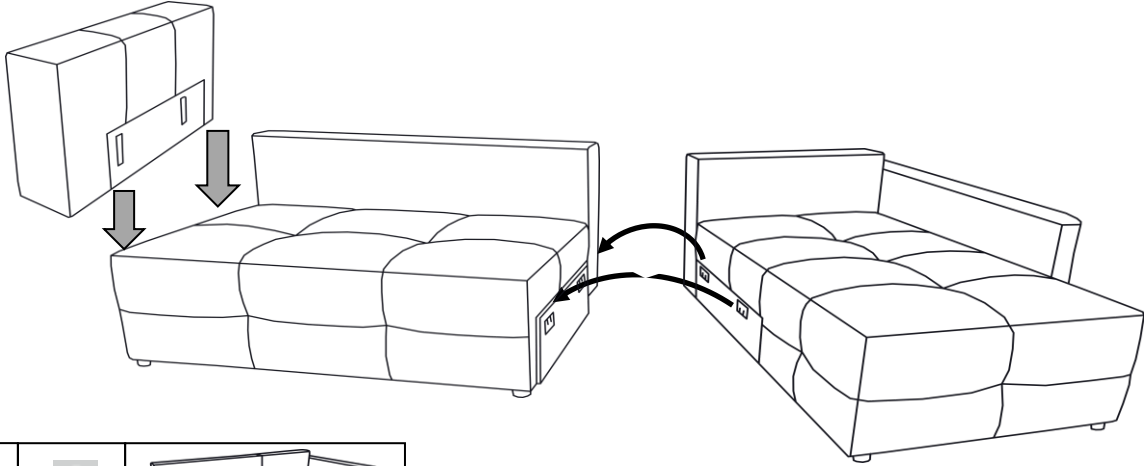
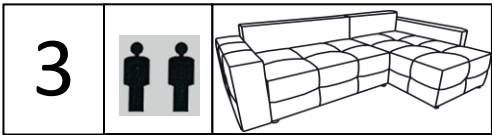



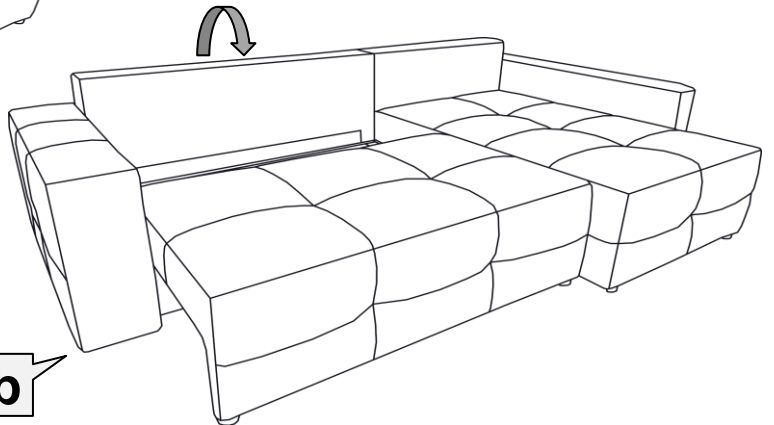

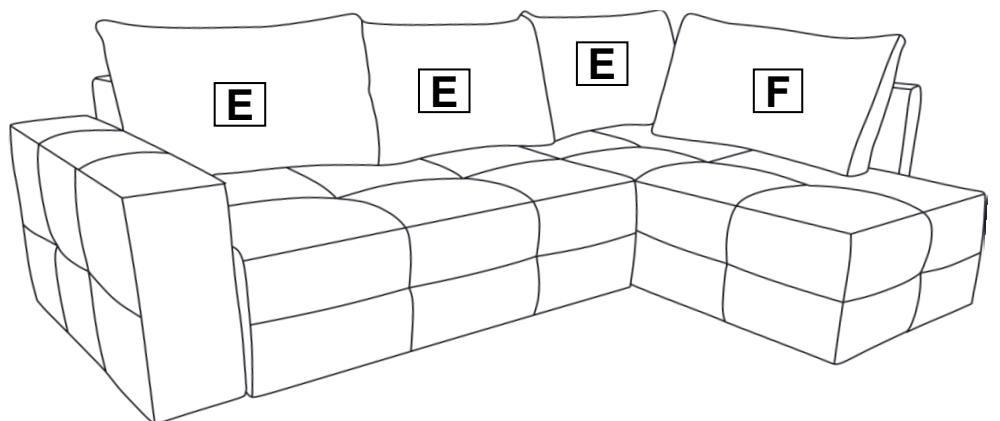
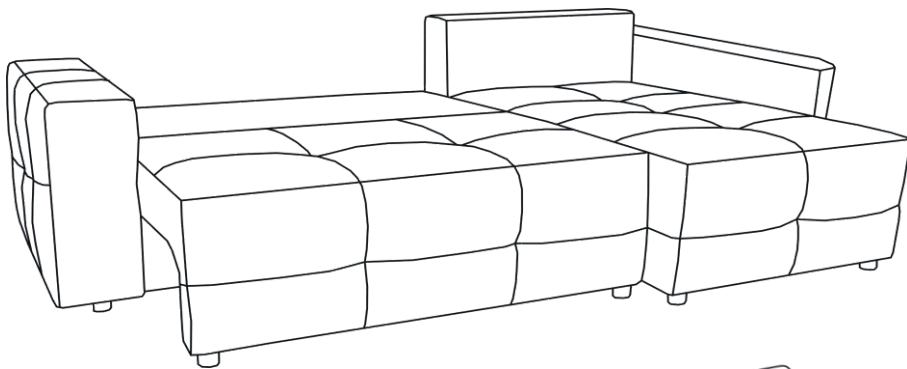

4a

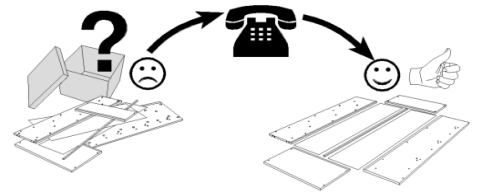
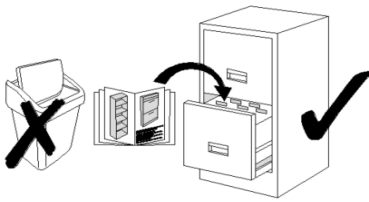

4b



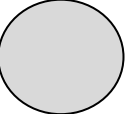

					
A M6x45 - 4	B M6x60 - 8	C x8	D FI30 - 10	E x3	F x1

Service – Dienstverlening – Serwis – Servis – Сервисная служба – Assistenza - Szerviz

Typ – Type – Тип – Тип – Типы - Tipo

A	
B	
C	
D	
E	
F	

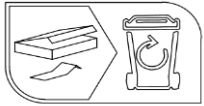
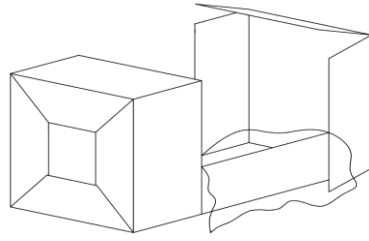

C PAP

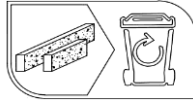

PS

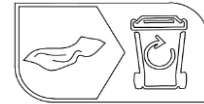

PVC

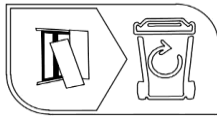

FOR

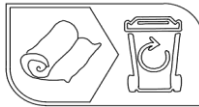

TEX



TEX



PET

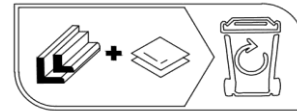

FE



ALU

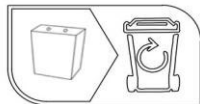

FOR



FE



PVC



PCW

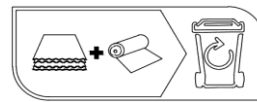

PP



PEHD

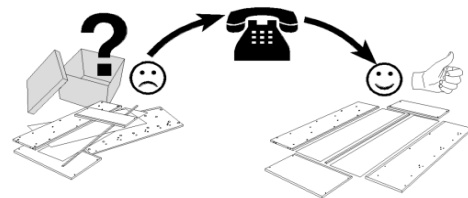
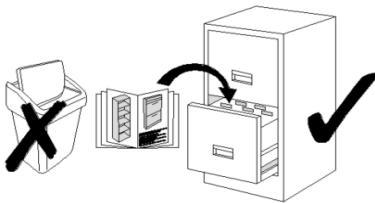

D – Recycling-Anweisungen
GB – Recycling instructions
NL – Instructies voor recycling
PL – Instrukcja recyklingu
TR – Geri dönüşüm talimatları
RU – Инструкции по переработке

RO – Instrucțiuni de reciclare
IT – Istruzioni per il riciclaggio
FR – Instructions de recyclage
SK – Pokyny na recykláciu
CZ – Pokyny k recyklaci
HU – Újrahasznosítási utasítások

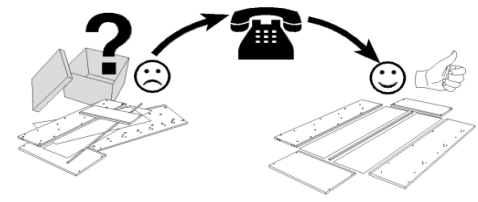
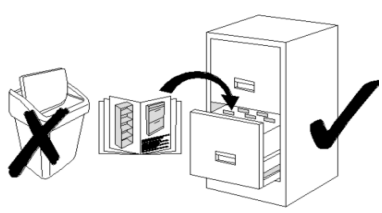
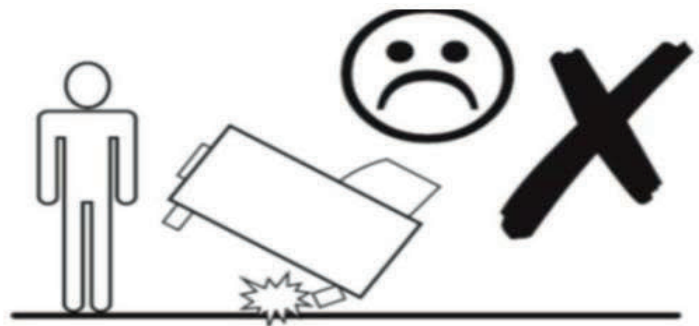
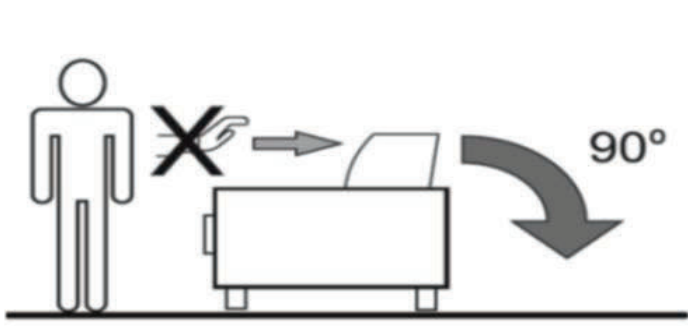
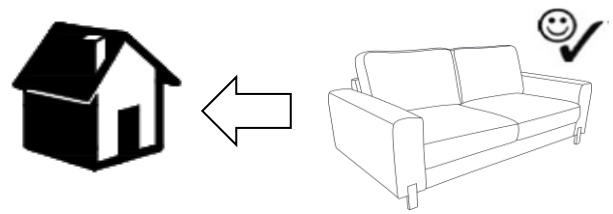
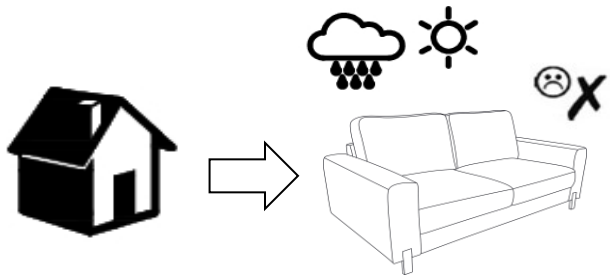
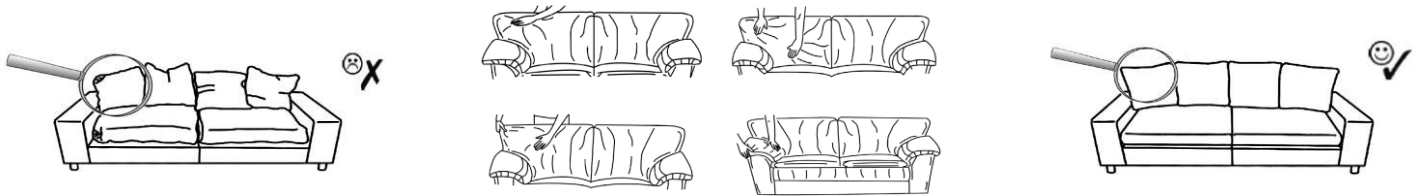
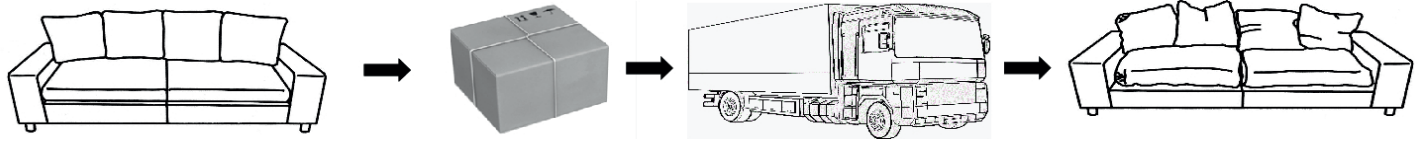

- D** – Bedienungsanleitung
- GB** – Instruction manual
- NL** – Gebruksaangwijzing
- PL** – Instrukcja obsługi
- TR** – Kullanım klavuzu
- RU** – ИНСТРУКЦИЯ ПО ЭКСПЛУАТАЦИИ

- RO** – Instrucțiuni de utilizare
- IT** – Manuale di istruzioni
- FR** – Manuel instructions
- SK** – Návod na použitie
- CZ** – Návod k použití
- HU** – Kezelési utasítás

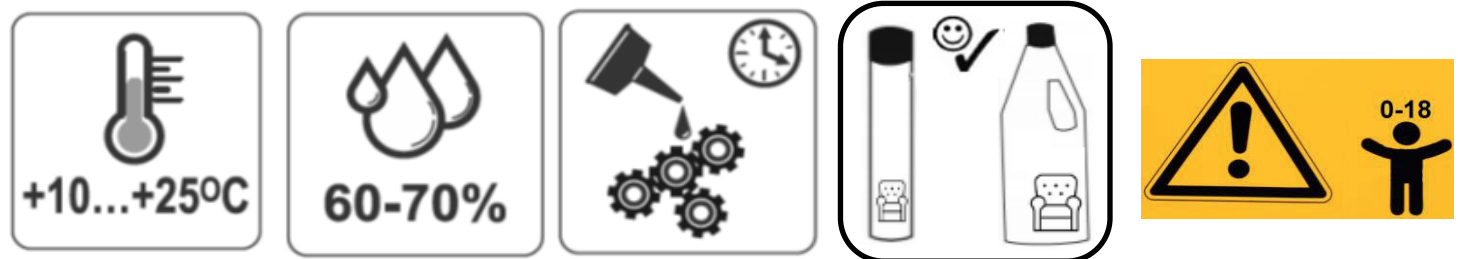
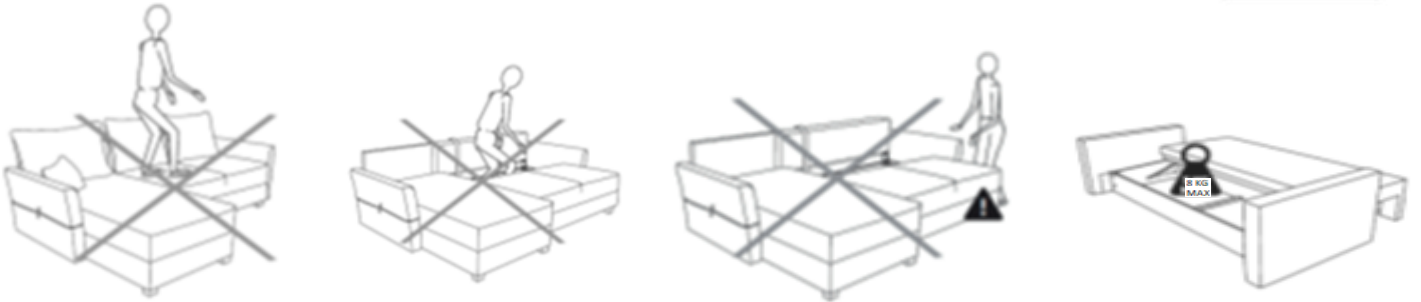
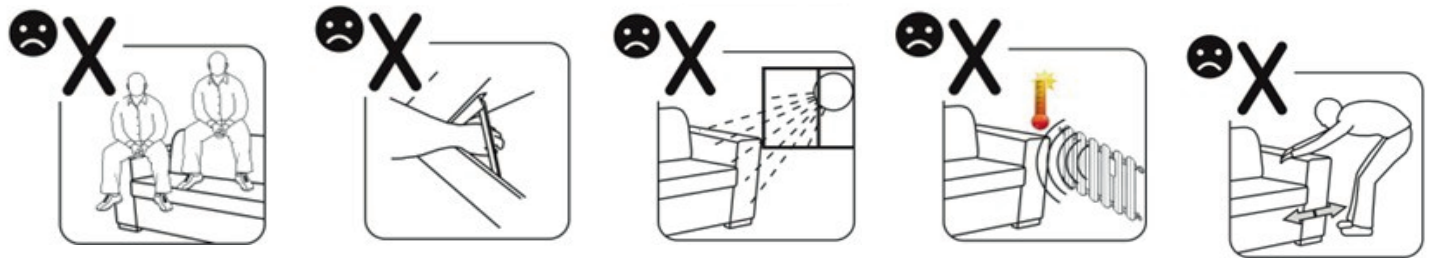
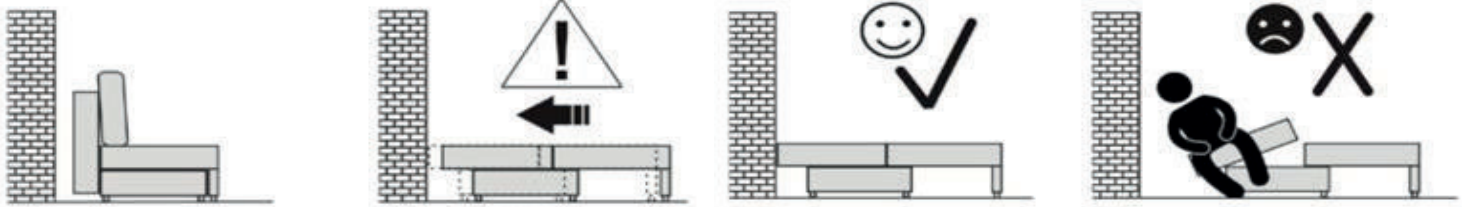

D – Bedienungsanleitung
GB – Instruction manual
NL – Gebruksaanzwijzing
PL – Instrukcja obsługi
TR – Kullanım klavuzu
RU – ИНСТРУКЦИЯ ПО
 ЭКСПЛУАТАЦИИ

RO – Instrucțiuni de utilizare
IT – Manuale di istruzioni
FR – Manuel instructions
SK – Návod na použitie
CZ – Návod k použití
HU – Kezelési utasítás