

**INSTRUKCJA MONTAŻU**  
**FITTING-UP INSTRUCTION**  
**ІНСТРУКЦІЯ МОНТАЖУ**  
**ИНСТРУКЦИЯ СБОРКИ**  
**MONTÁŽNY NÁVOD**  
**INSTRUCTIONS POUR LE MONTAGE**  
**INSTRUCCIONES DE MONTAJE**  
**SZERELÉSI ÚTMUTATÓ**  
**UPUTE ZA SASTAVLJANJE**  
**MONTAGEANLEITUNG**

Do montażu potrzebne są:  
 You need for fitting-up:  
 Для монтажу потрібно:  
 Для сборки нужны:  
 Pour le montage il faut:  
 Para realizar el montaje es necesario:  
 K montá i potrebujete:  
 A szereléshez szükséges:  
 Za sastavljanje su potrebne:  
 Für Montage werden benötigt:

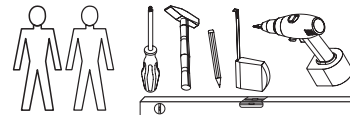

# Tue

## Sideboard 2D









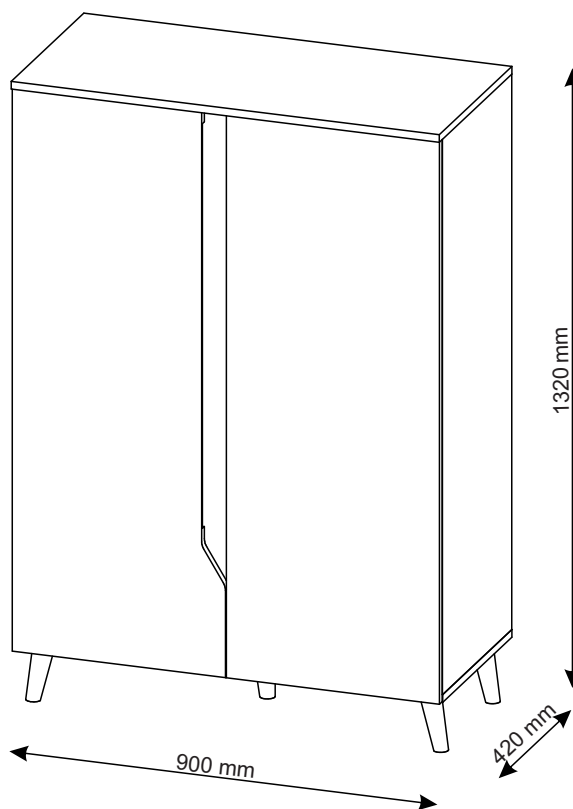









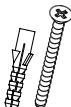

**PL** - Proszę nie montować mebla , jeśli jego elementy są uszkodzone.  
 Przed zmontowaniem poszczególne elementy mebla należy dokładnie obejrzeć.  
 W przypadku uszkodzeń , należy je zgłosić wraz z dokumentacją zdjęciową , celem rozpatrzenia reklamacji i podjęcia właściwych działań.

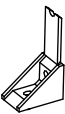
**EN**- Please do not assemble the furniture if its parts are damaged.  
 Before assembling, individual elements of the furniture should be carefully inspected.  
 In case of visible damage, it should be reported along with photographic documentation , to analyse the complaint and take appropriate action.

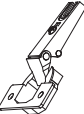
**FR** - Si vous constatez que les pièces sont endommagées, veuillez ne pas monter le meuble.  
 Avant le montage, les éléments individuels du mobilier doivent être soigneusement inspectés.  
 En cas d'un endommagement, ils doivent être signalés avec la documentation photographique afin d'examiner la réclamation et de prendre les mesures appropriées.

**DE** - Bitte montieren Sie die Möbel nicht, wenn ihre Teile beschädigt sind.  
 Vor dem Zusammenbau sollten einzelne Elemente der Möbel sorgfältig geprüft werden.  
 Im Schadensfall sollten sie zusammen mit der Foto Dokumentation gemeldet werden, um die Beschwerde zu prüfen und geeignete Maßnahmen zu ergreifen.



<b>A0</b>  Ø8x30 <b>x14</b>	<b>B0</b>  <b>x6</b>	<b>B1</b>  Ø7x50 <b>x6</b>	<b>C0</b>  <b>x8</b>	<b>C1</b>  16 mm <b>x8</b>	<b>C2</b>  <b>x8</b>	<b>D0</b>  3x15 <b>x18</b>	<b>D17</b>  3.5x16 <b>x13</b>	<b>D10</b>  4x16 <b>x12</b>	<b>D32</b>  6x30 <b>x5</b>	<b>E4</b>  8x50 <b>x2</b>	<b>F0</b>  <b>x18</b>
<b>F1</b>  <b>x3</b>	<b>Z</b>  4mm <b>x1</b>	<b>G1A</b>  <b>x6</b>	<b>G1B</b>  <b>x6</b>	<b>H0</b>  <b>x16</b>	<b>I1</b>  <b>x2</b>	<b>M3</b>  <b>x3</b>	<b>T21</b>  <b>x5</b>	<b>U0</b>  <b>x4</b>			

- PL** Powierzchnię mebli należy czyścić tylko środkami do pielęgnacji mebli. Szanowny kliencie w przypadku reklamacji prosimy wypełnić druki reklamacyjne dostępne w punktach sprzedaży przedkładając Kartę Reklamacyjną (zawierającą datę produkcji i numer pakowacza lub zmiany pakowania) umieszczona w każdej z paczek, oraz instrukcję montażu mebla, gdzie prosimy o zaznaczenie uszkodzonego elementu.
- SK** Povrch nábytku čistite iba prostriedkami určenými na ošetrovanie nábytku.Vá ení zákazníci! V prípade reklamácie prosíme, aby ste vyplnili tlačivá, ktoré sú prístupné v obchodoch, predlo ili Reklamačný list (ktorý obsahuje dátum výroby a číslo baliča alebo číslo zmeny pri balení), ktorý sa nachádza v ka dom balení a návod na montá nábytku, v ktorom označte poškodenú čas.
- CZ** Povrch nábytku čistěte pouze přípravky určenými k ošetřování nábytku.Vá ený zákazník, v případě uplatnění reklamacie vyplňte prosím reklamační formuláře, které jsou dostupné v prodejnách a předlo te Reklamační kartu (obsahující datum výroby a číslo balení nebo změny balení, která je umístěna v balíčku) a návod k obsluze s vyznačením poškozeného dílu.
- BG** Повърхността на мебелите трябва да се почиства само с препарати за поддържане на мебели.Уважаеми клиенти, в случай на рекламация моля попълнете формулярите за рекламация, които ще получите в търговските пунктове, като представите Картата за рекламация (съдържаща датата на производство и номера на опаковчика или смяната за опаковане), която ще намерите във всяка опаковка, и инструкцията за монтаж на мебела, върху която да отбележите повредения елемент.
- RO** Suprafața ei trebuie să fie curățată numai cu substanțe destinate pentru curățarea mobilei.Stimate Cumpărător, în caz de reclamatie vă rugăm să completați formularul de reclamatie pe care îl puteți lua de la punctul de vânzare și pe care îl veți prezenta împreună cu Cartela de Garanție ( care conține data producției și nr ambalatorului sau țurei de ambalare), însoțită la fiecare ambalaj, precum și instrucțiunile de montaj ale mobilei, pe care vă rugăm să marcați elementul deteriorat.
- UA** Поверхня меблів треба чистити тільки засобами для догляду за мебелю.Уважаемий клієнт для заяви рекламачії, просимо заповнити формуляр рекламачії, доступний у пунктах продажу, вказуючи рекламачійного карту (містить дату виробництва та номер пакувальника або зміни упаковки), прикладену до кожного пакету, а також інструкцію з монтажу меблів, на якій просимо позначити пошкоджений елемент.
- RUS** Поверхность мебели надо чистить только средствами для ухода за мебелью.Уважаемый клиент для заявления рекламации, просим заполнить формуляр рекламации, доступный в пунктах продажи, указывая Рекламационную карту (содержащую дату производства и номер упаковщика или смены упаковки), приложенную к каждому пакету, а также инструкцию по монтажу мебели, на которой просим обозначить поврежденный элемент.
- DE** Reinigen Sie den Möbelbereich nur mit Möbelpflege. Kunden, bei Beanstandung Bitte füllen Sie die Reklamationsformulare, die in den Verkaufsabteilungen erhältlich sind, vor dem Verkauf aus eine Reklamationskarte (mit Angabe des Produktionsdatums und der Anzahl der Personen, die die Waren verpacken, oder der Anzahl der Schichten) Verpackung), die in jeder Packung enthlten ist, und Halterungen, in denen Sie reichlich vorhanden oder beschädigt sind ElementeReinigen Sie den Möbelbereich nur mit Möbelpflege. Kunden, bei Beanstandung.
- GB** Furniture surface must be cleaned only with furniture maintenance formulas.Dear Customer, should you wish to file a complaint, we would request you to fill in the complaint forms available in our outlets, submitting the Complaint Card (specifying the date manufactured, packaging employee/ shift code) enclosed in each of the packets, together with the Assembly Manual, where please highlight the faulty component.
- H** A bútorok felületét kizárólag a bútorápolószerekkel lehet tisztítani. Tisztelt Vásárló! Reklamáció esetén kérjük az eladási helyeken kapható reklamációs nyomtatványokat kitölteni a Reklamációs Lap (tartalmazza a gyártási dátumát és csomagoló számát vagy műszakszámát) bemutatásával, amely mindegyik csomagban található, valamint a bútor szerelési utasítását, amelyen kérjük a sérült elemet bejelölni sziveskedjék.
- FR** La surface des meubles ne peut être nettoyée qu'avec des produits pour l'entretien de meubles. Cher Client, en cas de réclamation, veuillez bien remplir des formulaires de réclamation accessibles dans les centres de vente en montrant le mode d'emploi pour monter le meuble. Nous vous demandons de bien vouloir y entourer l'élément en panne.
- ES** Limpiar la superficie de muebles exclusivamente con los agentes para el cuidado de los muebles.Estimado Cliente, en caso de reclamaciones, hagan favor de rellenar los formularios de reclamación disponibles en los puntos de venta, presentando las instrucciones de montaje de mueble, donde es necesario indicar un elemento estropeado.



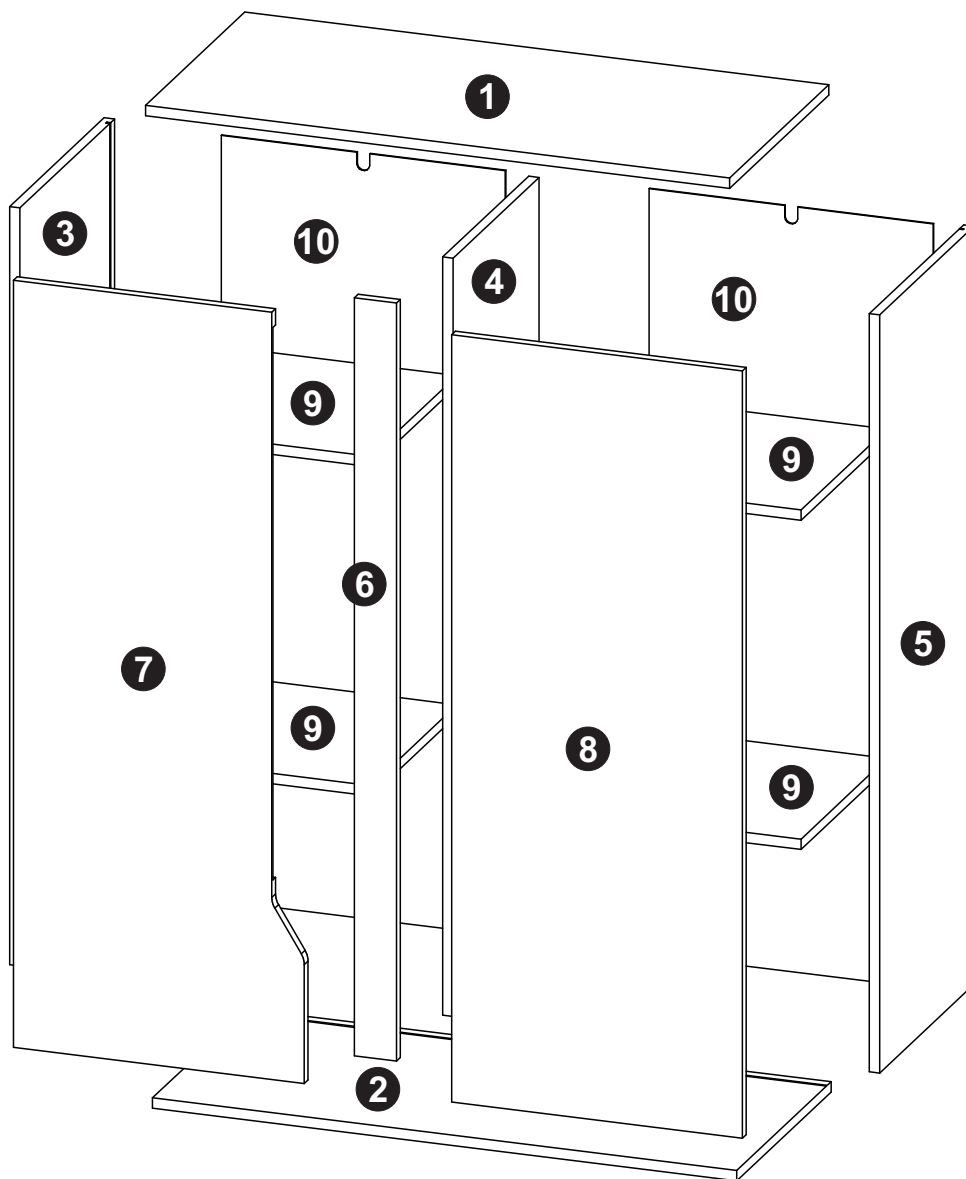

1	900x420	1
2	900x400	1
3	1168x400	1
4	1168x363.5	1
5	1168x400	1

6	1168x65	1
7	1182x448	1
8	1182x448	1
9	425x360	4
10	1178x437	2

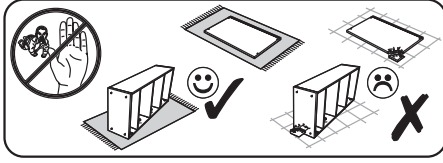





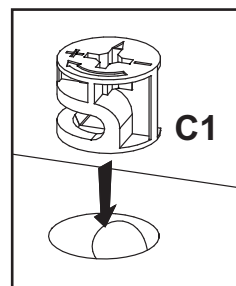
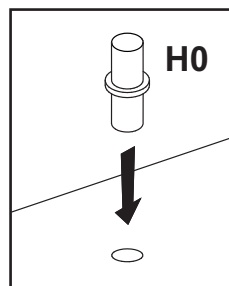
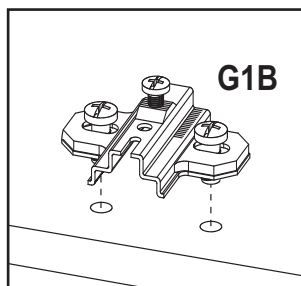
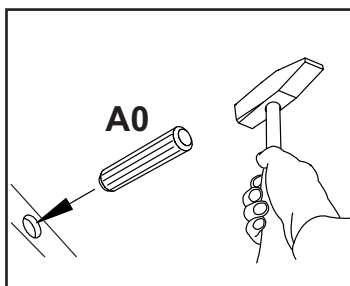
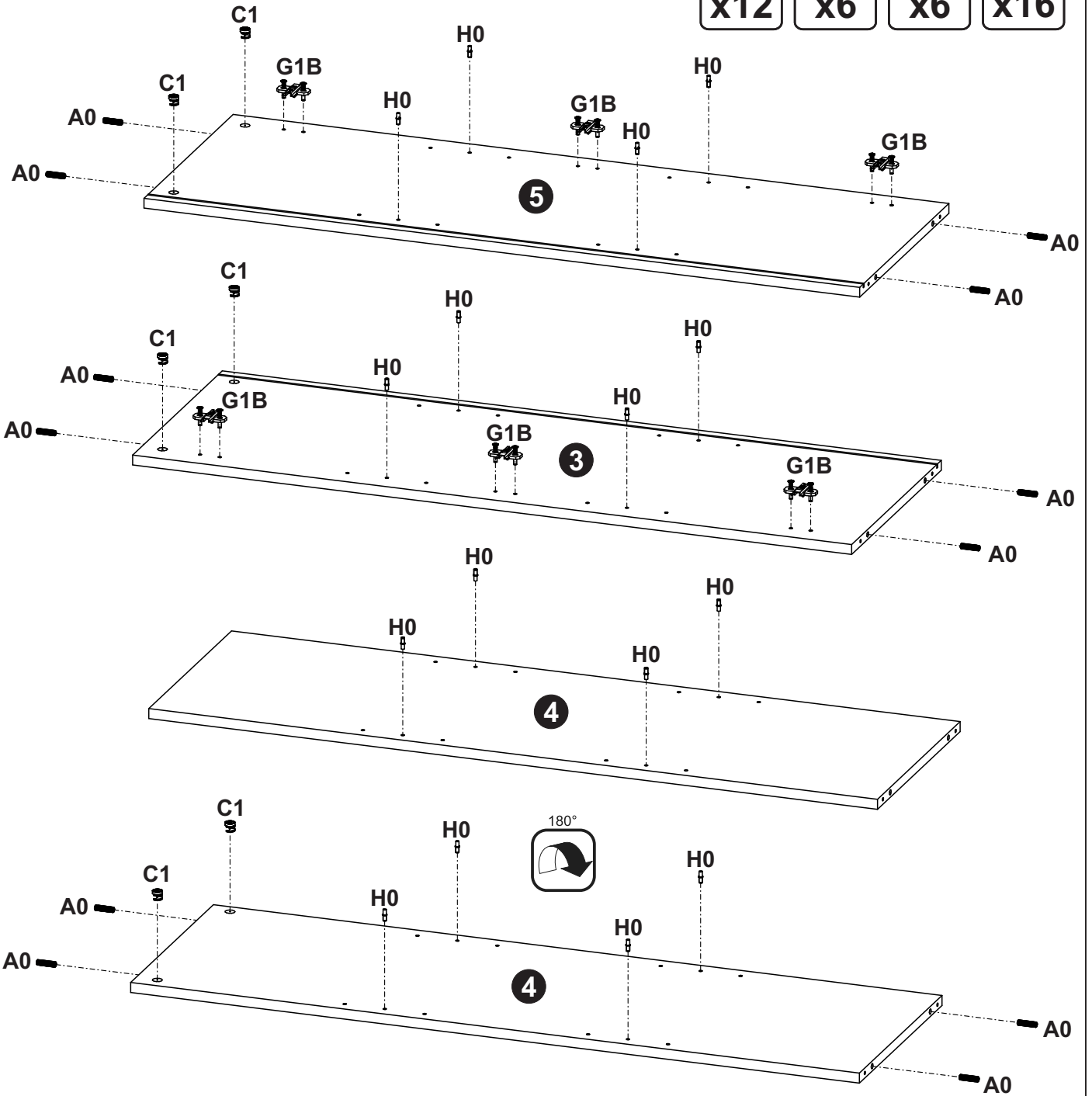

# 1



<b>A0</b>  Ø8x30 <b>x12</b>	<b>C1</b>  16 mm <b>x6</b>	<b>G1B</b>  <b>x6</b>	<b>H0</b>  <b>x16</b>
---	--	--	--



# 2

<b>C1</b>	<b>C2</b>	<b>D17</b>	<b>D32</b>	<b>I1</b>	<b>T21</b>	<b>A0</b>
						
16 mm		3.5x16	6x30			Ø8x30
<b>x2</b>	<b>x8</b>	<b>x4</b>	<b>x5</b>	<b>x2</b>	<b>x5</b>	<b>x2</b>

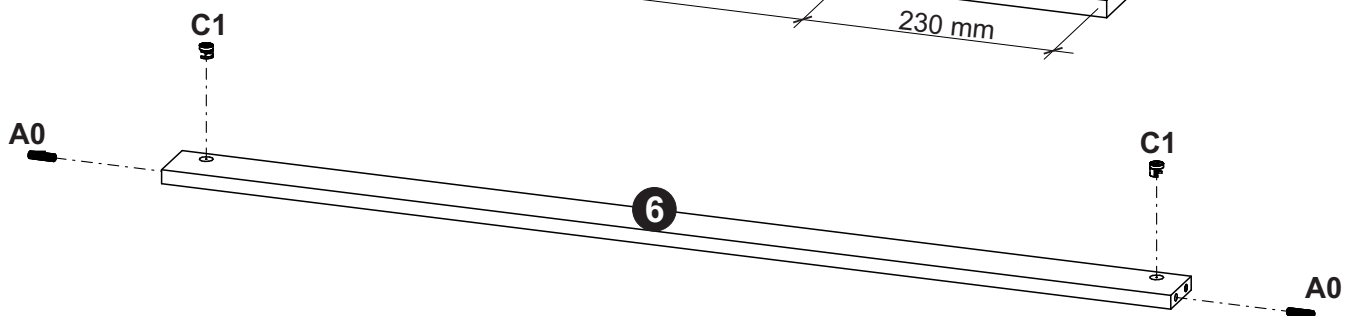
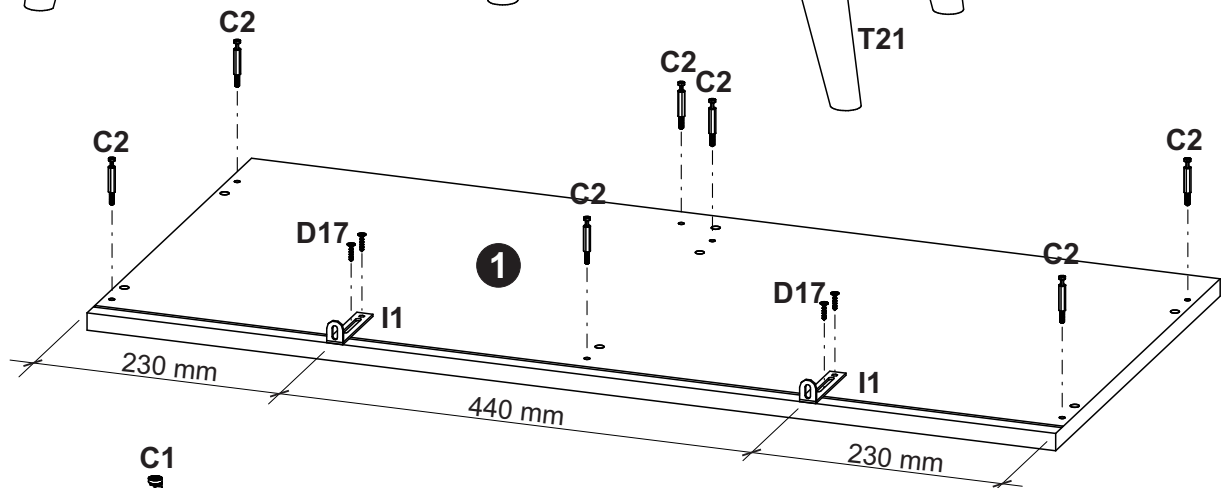
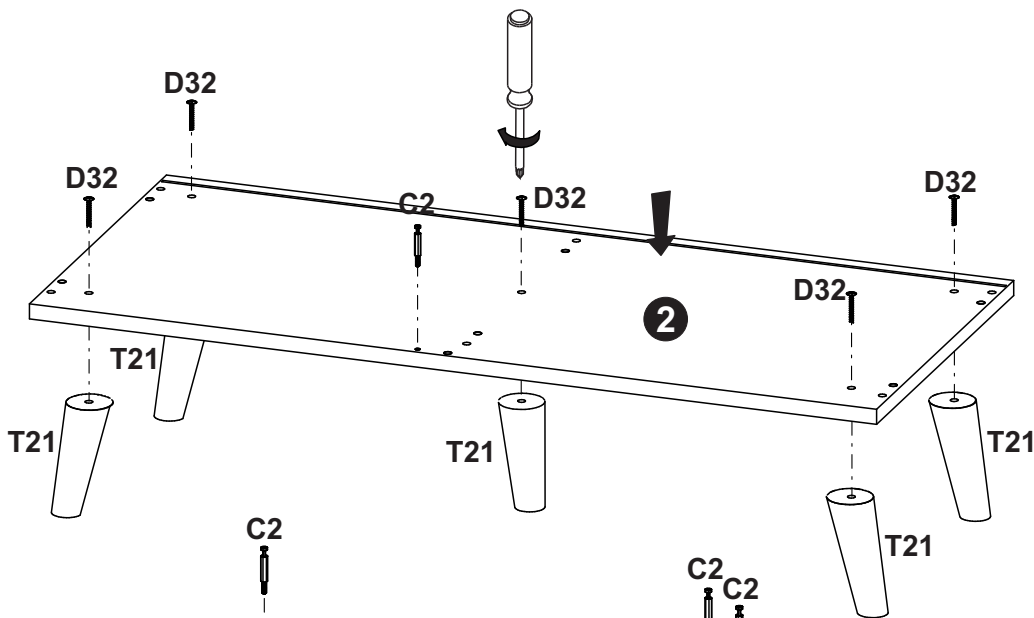
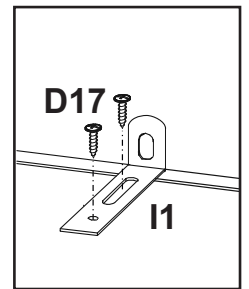
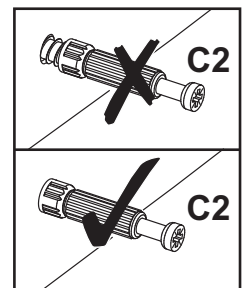
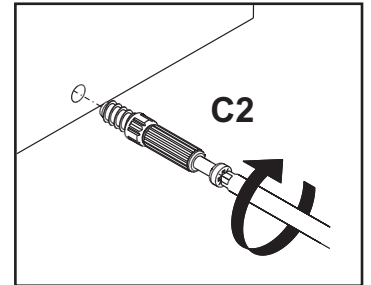
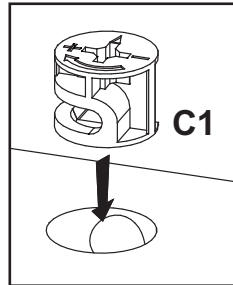
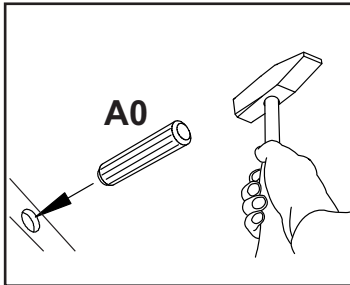

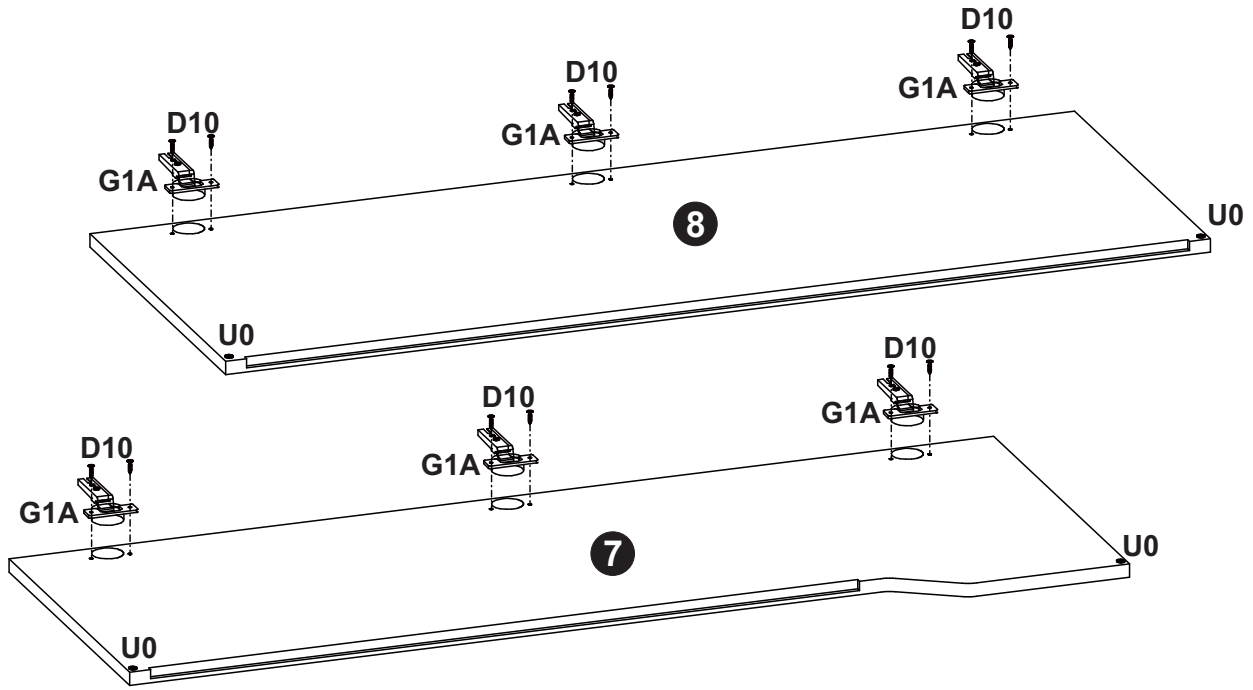
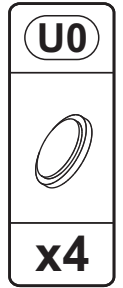
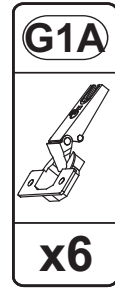
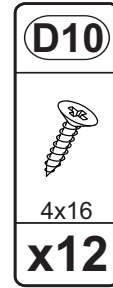
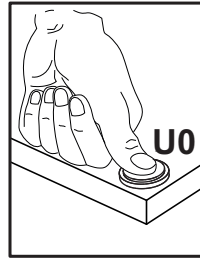
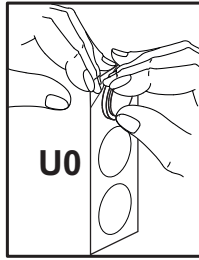
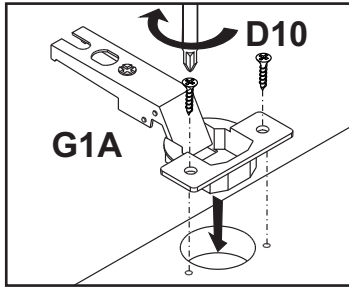

# 3

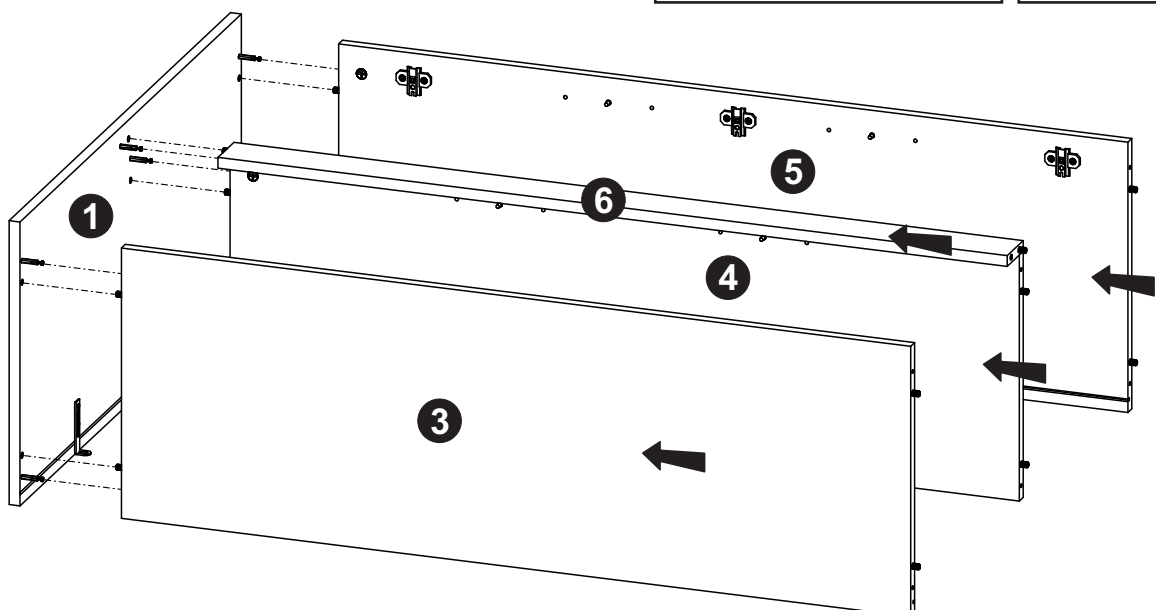
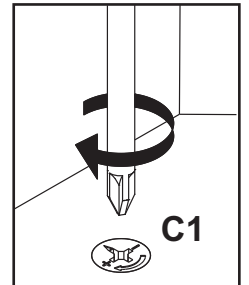
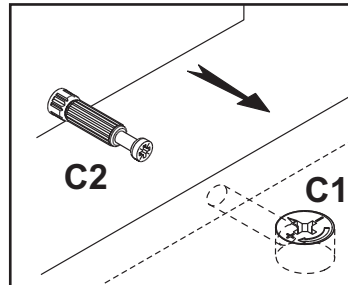

# 4





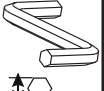

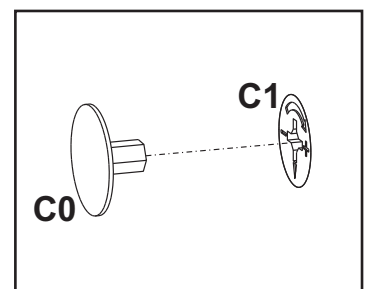
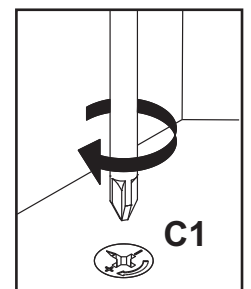
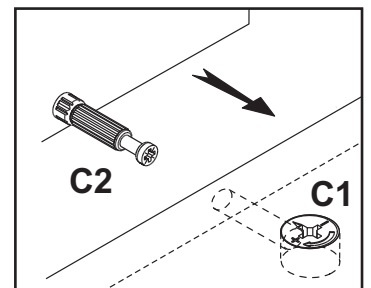
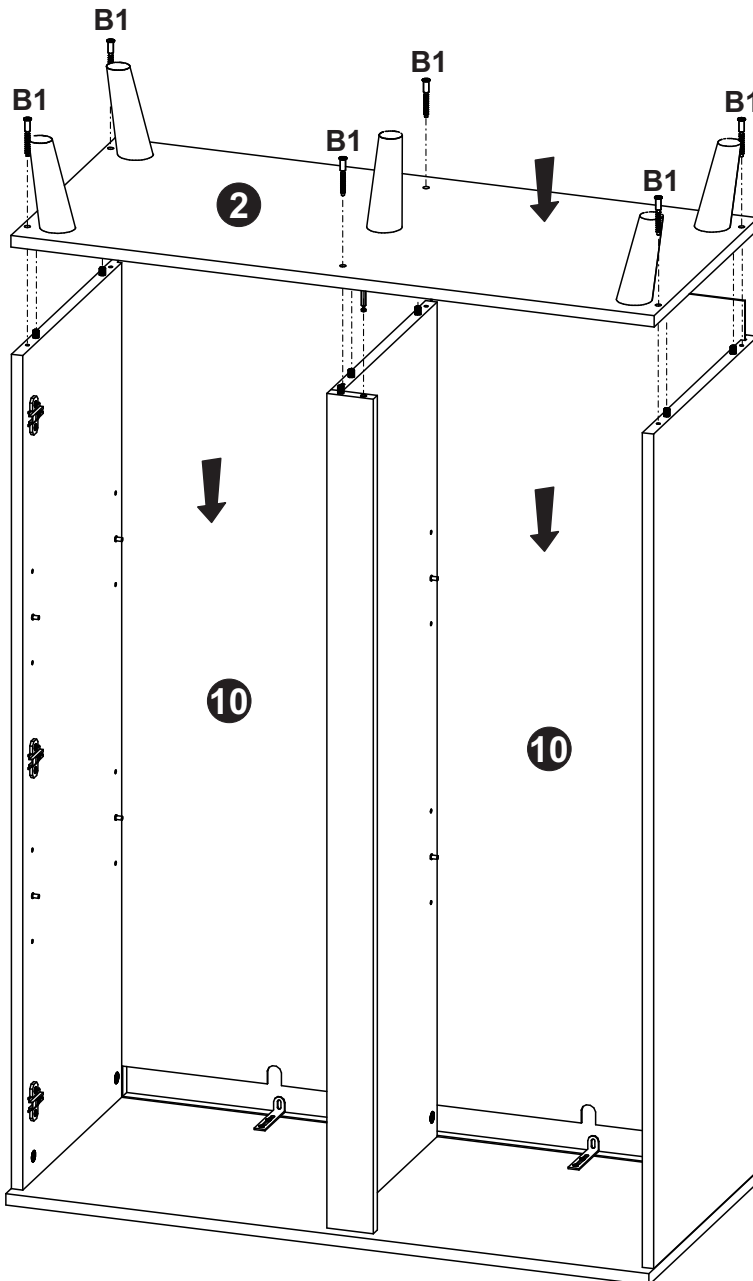
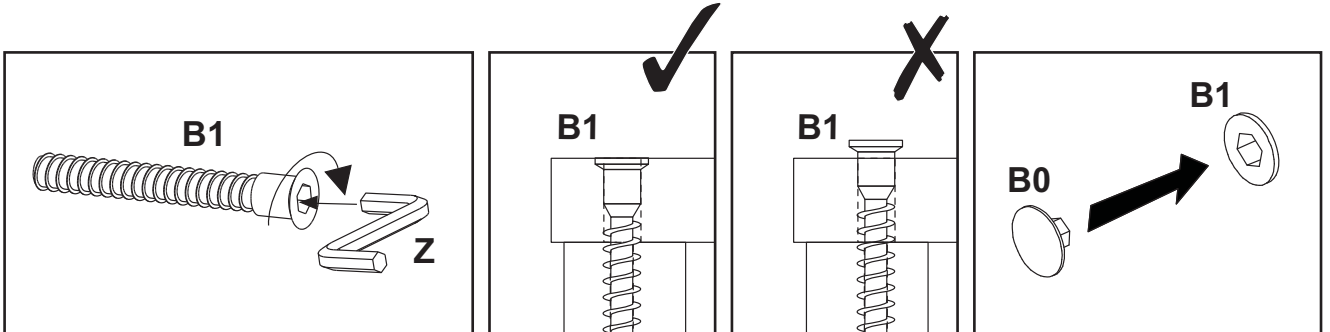
# 5

<b>B0</b>	<b>B1</b>	<b>C0</b>	<b>Z</b>
	 Ø7x50		 4mm
<b>x6</b>	<b>x6</b>	<b>x8</b>	<b>x1</b>



# 6

<b>D0</b>	<b>D17</b>	<b>F0</b>	<b>M3</b>
			
3x15	3.5x16		
<b>x18</b>	<b>x3</b>	<b>x18</b>	<b>x3</b>

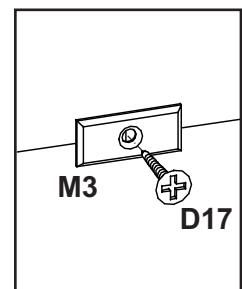
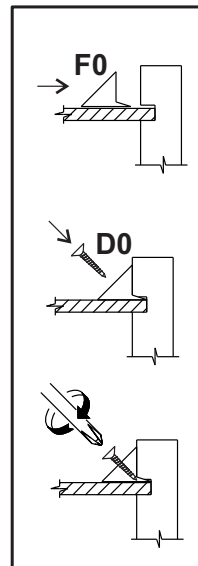
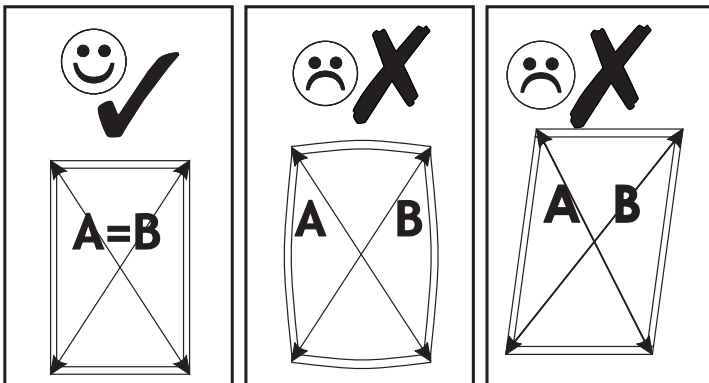
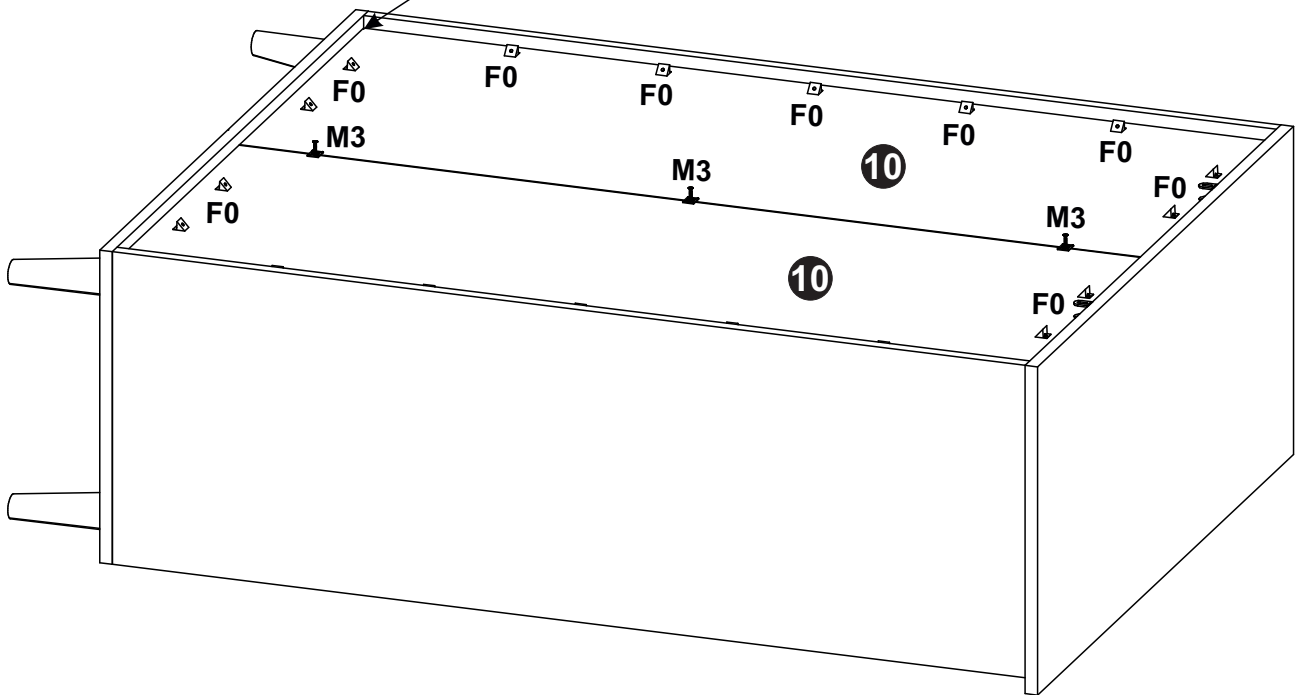
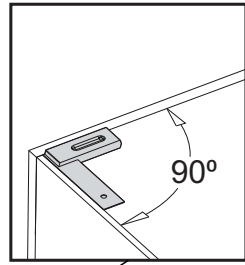

# 7

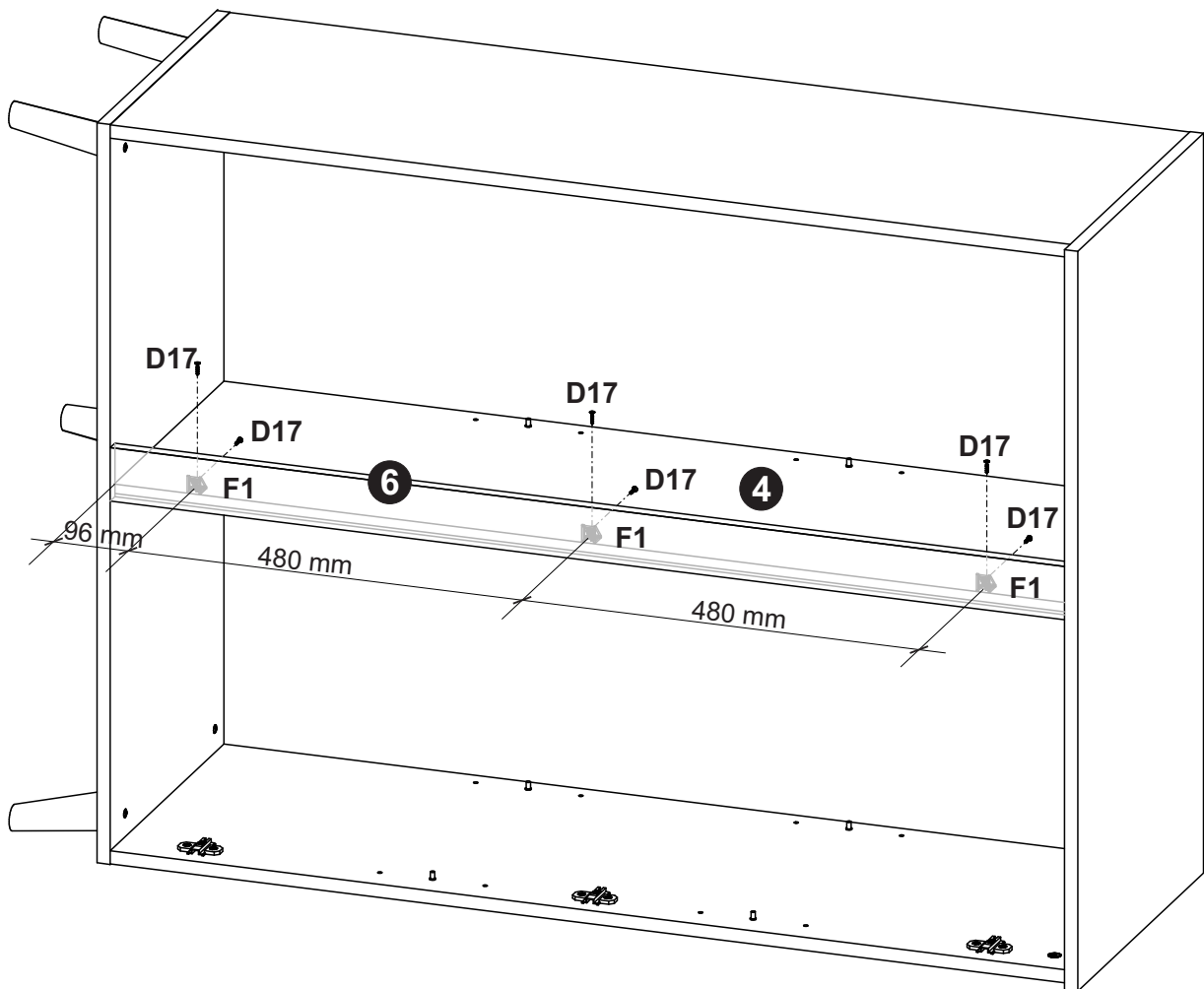
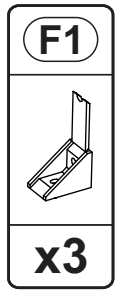
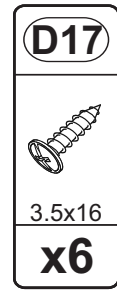
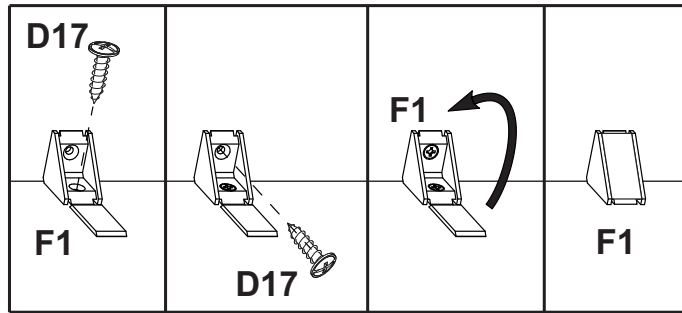

# 8

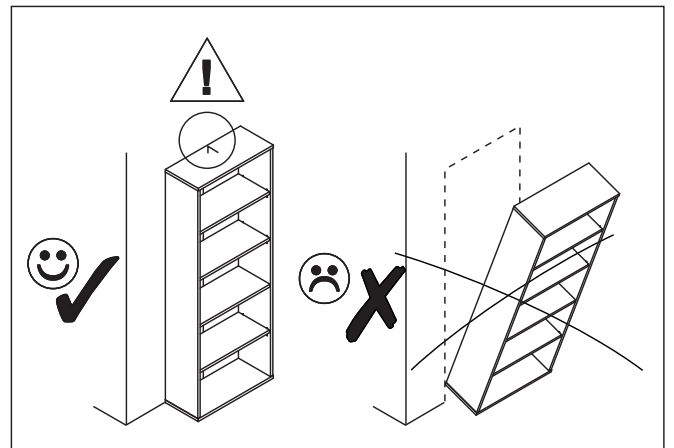
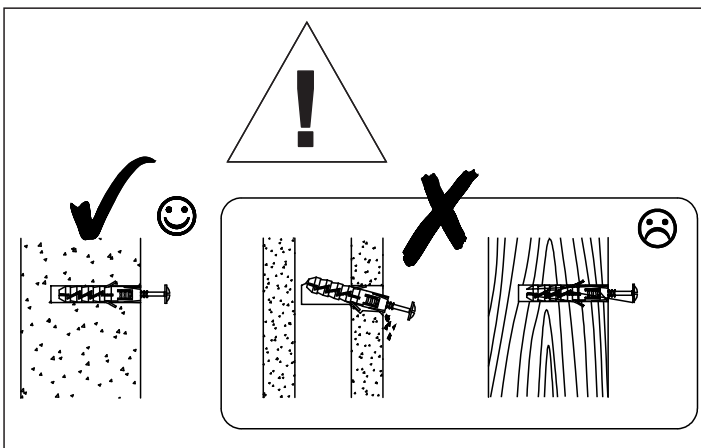
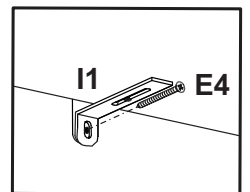
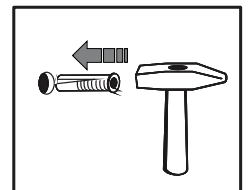
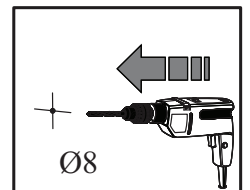
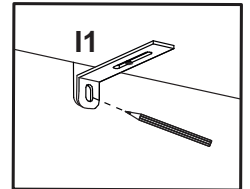
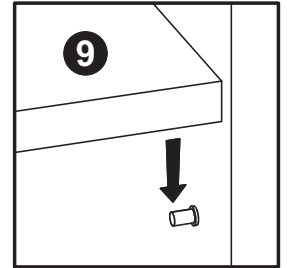
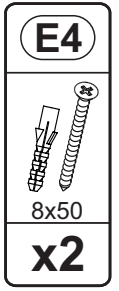
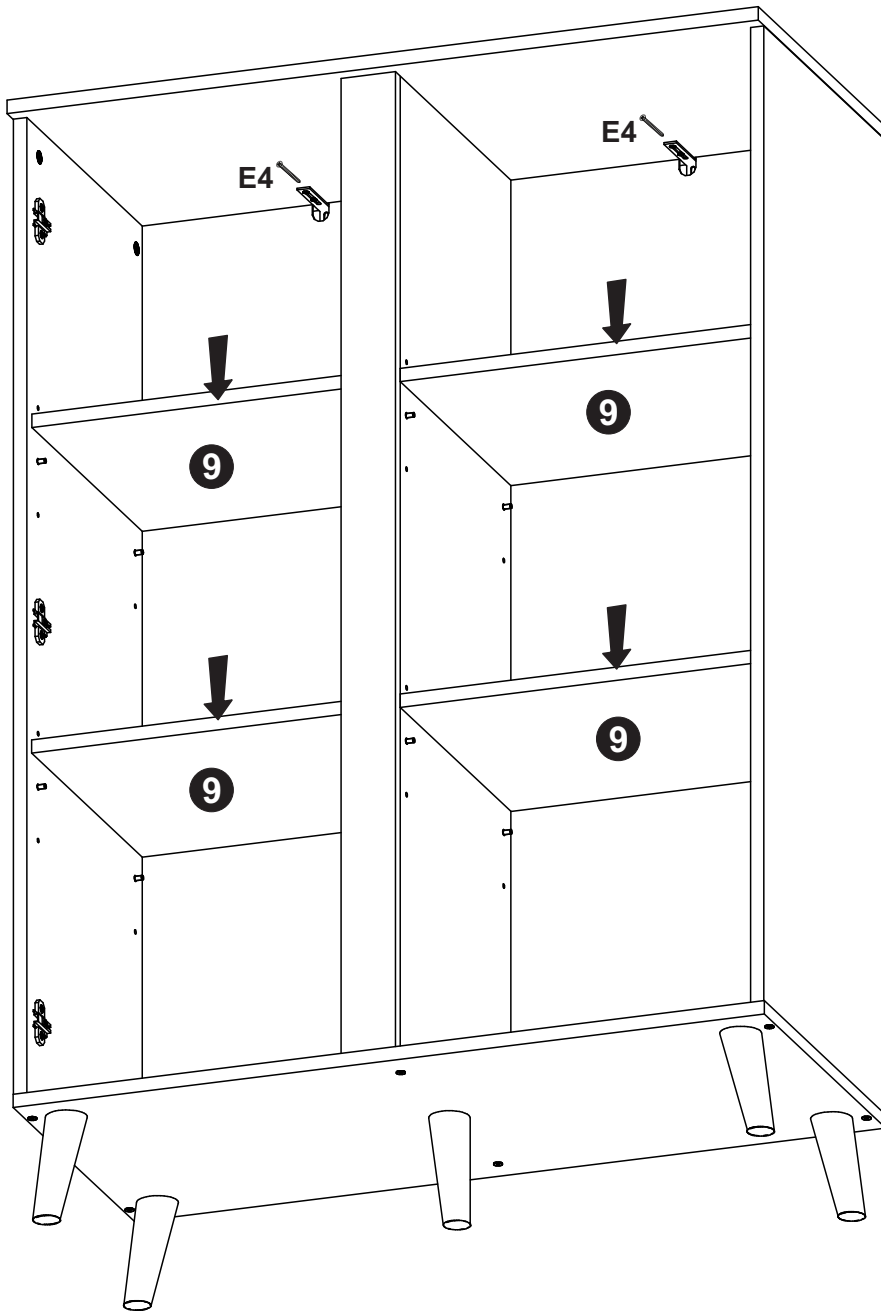

9

