

VILA

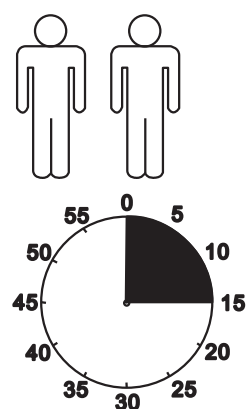

1

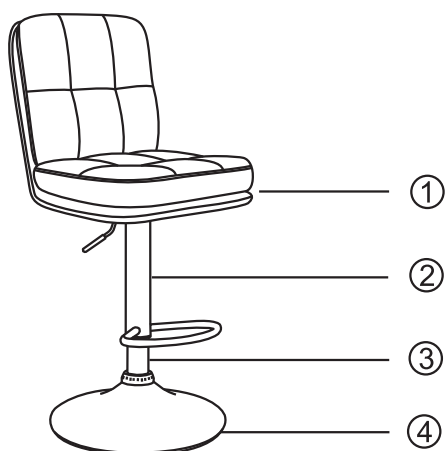
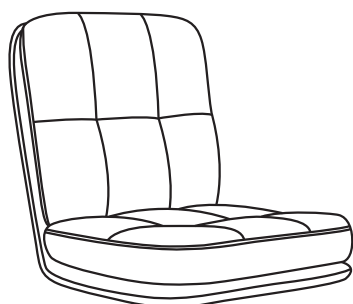

2

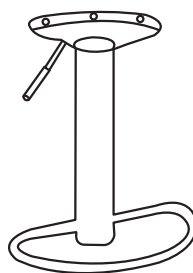

3



4

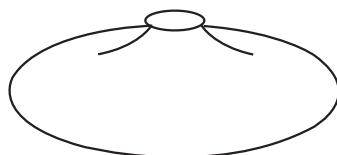

1	1x
2	1x
3	1x
4	1x



1/1

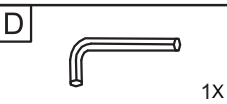
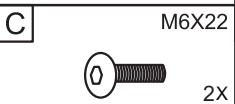
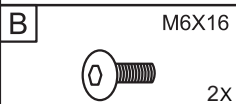

1.

1.

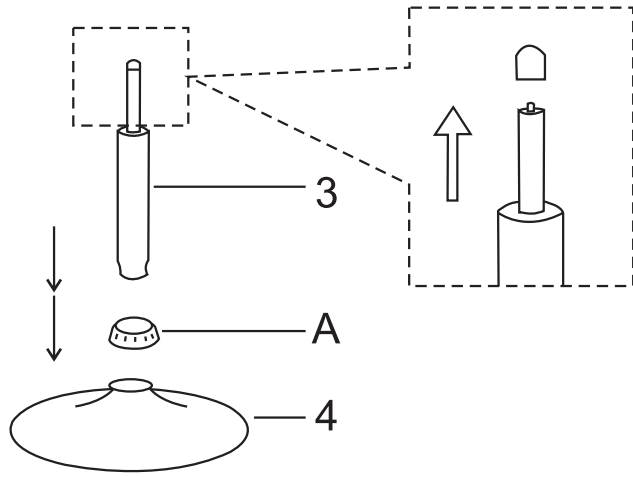

A

1X

2.

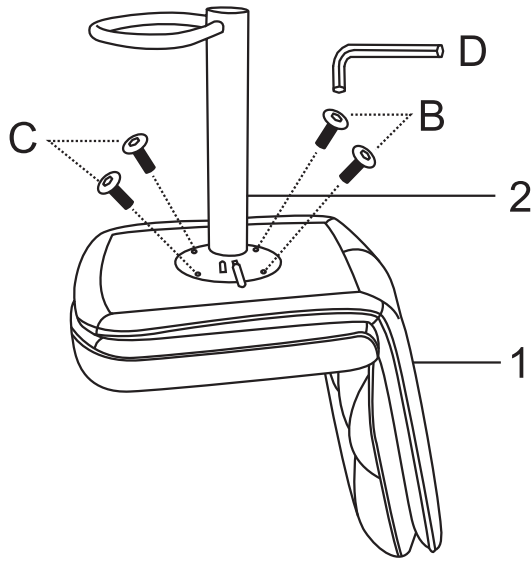

B

M6X16
2X

C

M6X22
2X

D

1X

3.

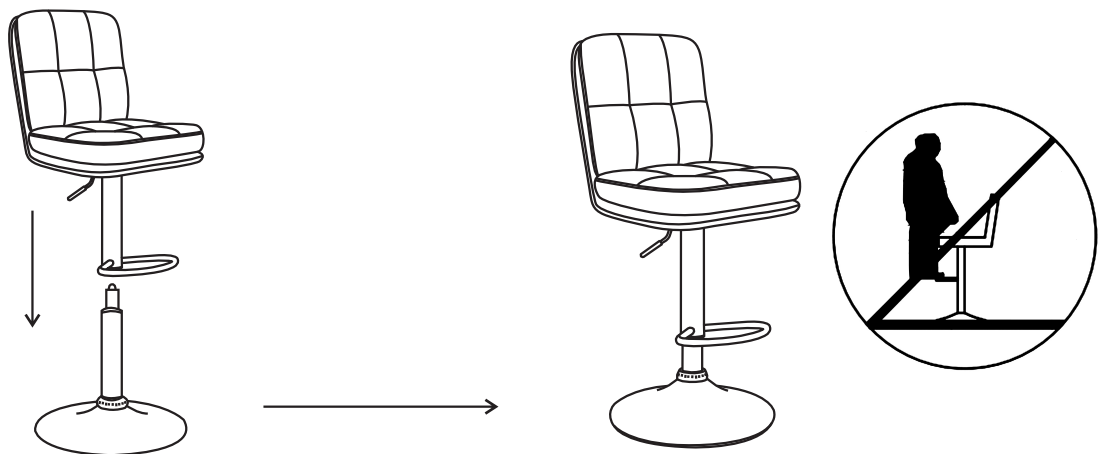

Séparez les éléments avant de trier