

# SABINE

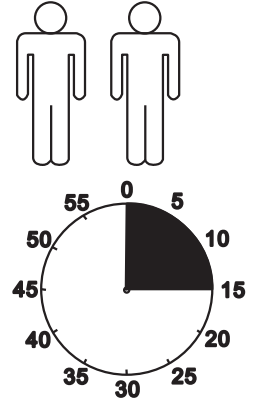

1

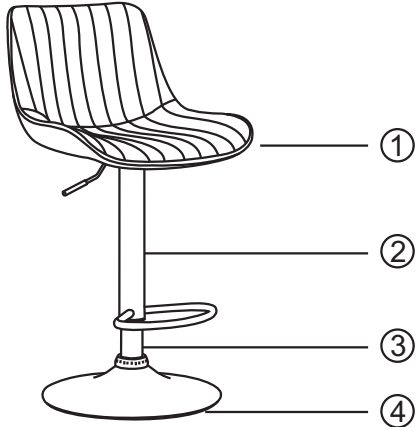
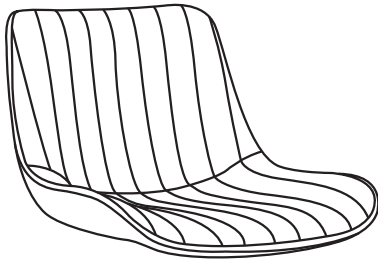

2

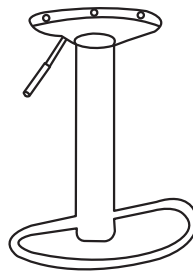





3

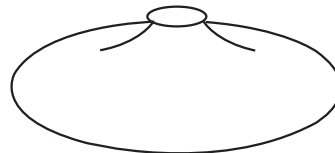

4



1	1x
2	1x
3	1x
4	1x

	1/1				
A 	1X	B  M6X16	4X	C 	1X

I.

1.

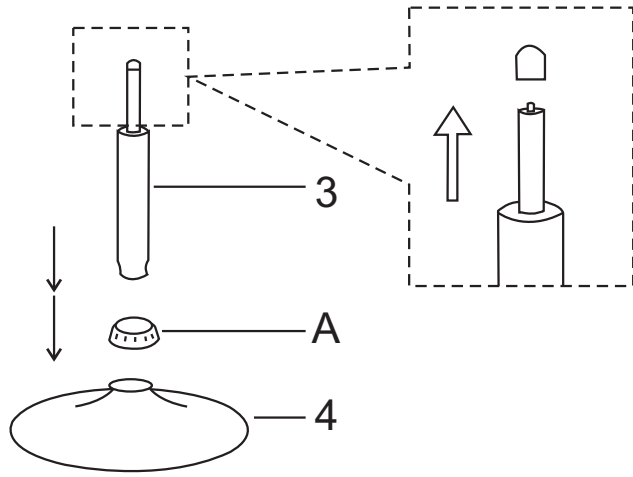

A



1X



75%

2.

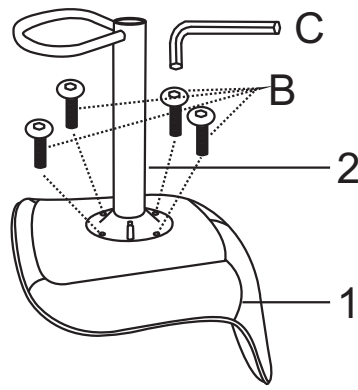

B



M6X16  
4X

C

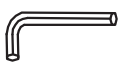

1X



100%



3.

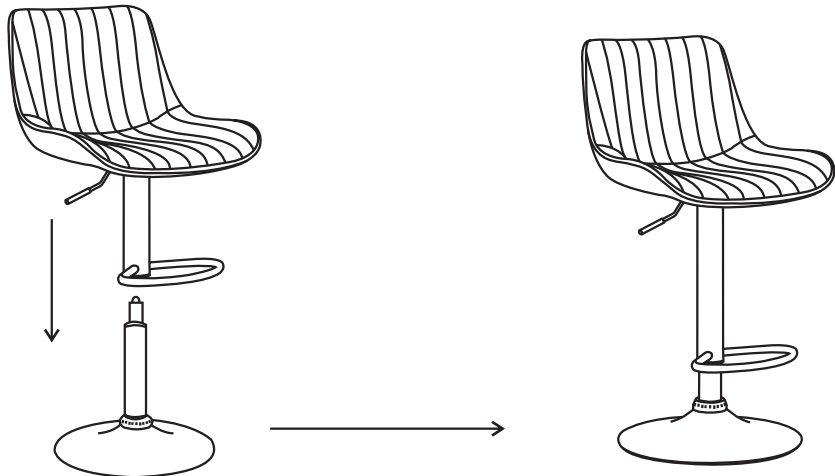

**LE TRI + FACILE**



**BAC DE TRI**

Séparez les éléments avant de trier