

Bella (2AL-RCHO)(RCHO-2AL)variabel



- | | |
|----------------------------------|--------------------------------|
| (DE) Montageanleitung | (FR) Notice de montage |
| (PL) Instrukcja montażu | (RO) Instrucțiuni de asamblare |
| (NL) Handleiding voor de montage | (SK) Montážny návod |
| (GB) Assembly instructions | (CZ) Montážní návod |
| (TR) Montaj talimatı | (HU) Szerelési útmutató |
| (RU) Инструкция по монтажу | (SLO) Navodila za montažo |
| (IT) Istruzioni di montaggio | |

Service - Servis - Dienstverlening - Servis - Serwis - Сервисная служба - Servizio - Service
 Serviciu - Služby - Szolgáltatás - Storitev

Da es sich hier um ein variables Modell handelt, muss vor Montage entschieden werden, welches Element rechts oder links stehen soll. Entsprechend müssen dann die Arm- bzw. Rückenlehnen angebracht werden. Hierzu den Reißverschluss an der Unterseite öffnen und anhand der vorhandenen Bohrungen in den Seitenwänden die Löcher im Stoff freilegen (Schere, Cuttermesser o.ä.).

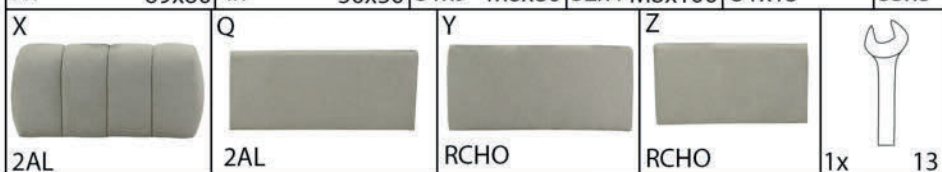
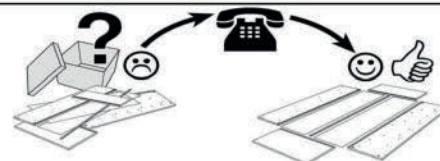

2AL-RCHO
L=2-4







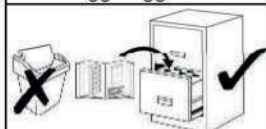
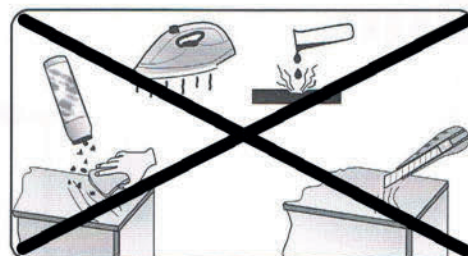
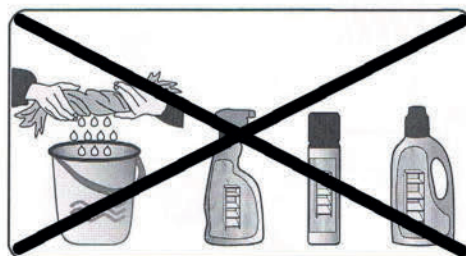
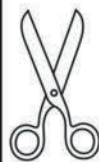
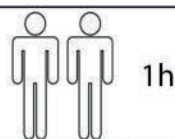

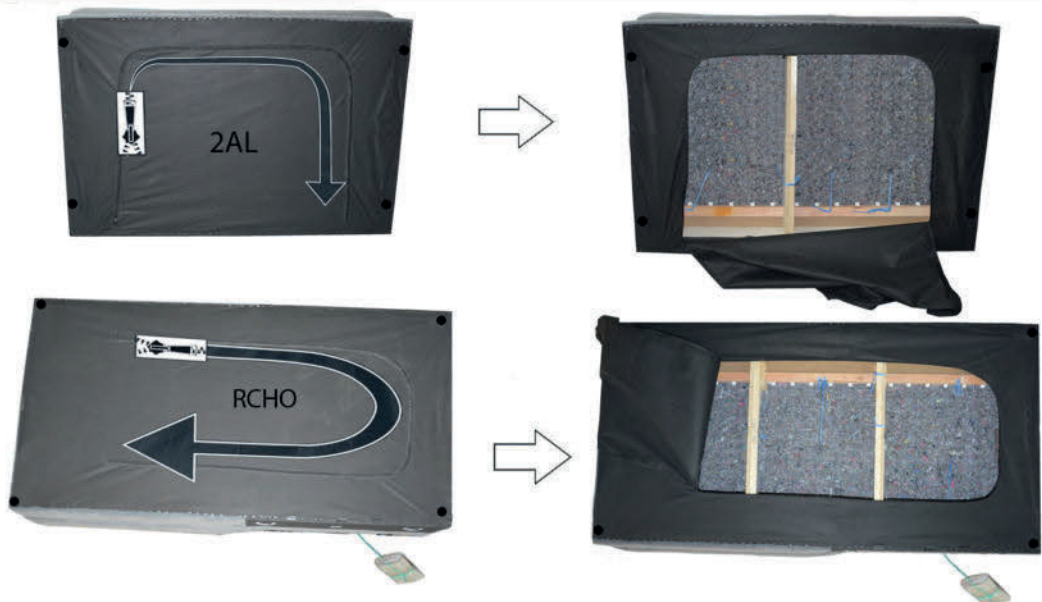

RCHO-2AL
R=5-7

10-06-2026

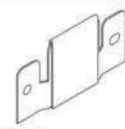



 S1x6	 U1x6	 S3x4	 M6x20	 B2x2	 X	 Q	 L
					2AL	2AL	2AL-RCHO

1x 

13

1

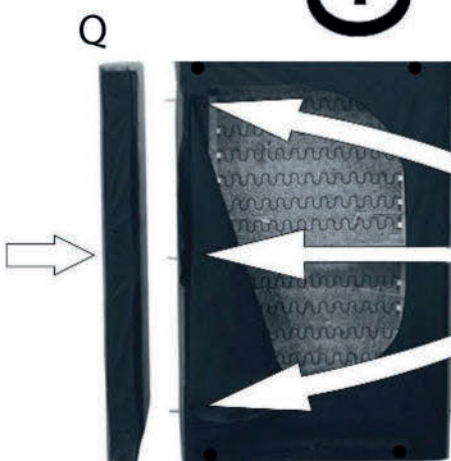

Q

2

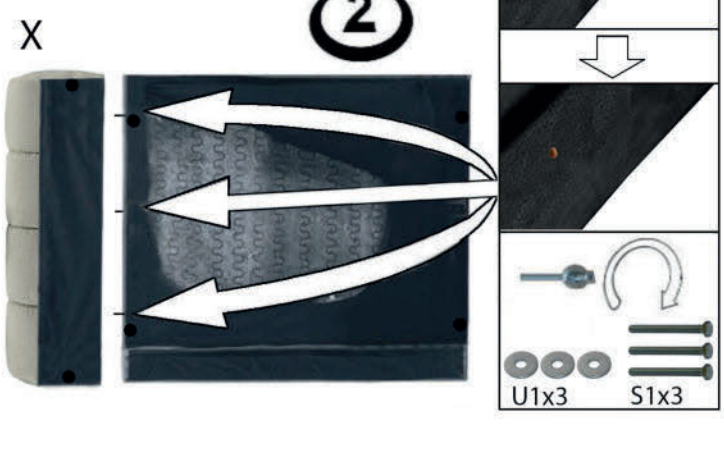

X

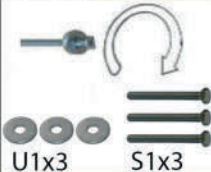

U1x3 S1x3



U1x3 S1x3

3

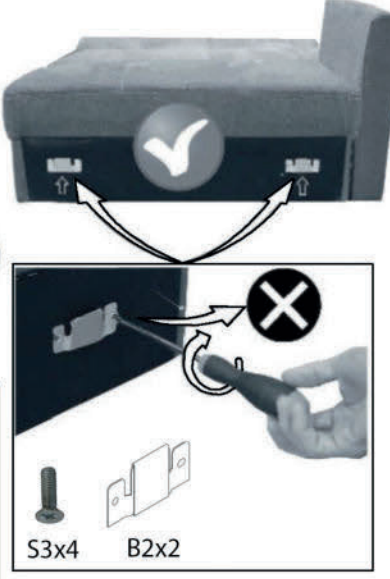

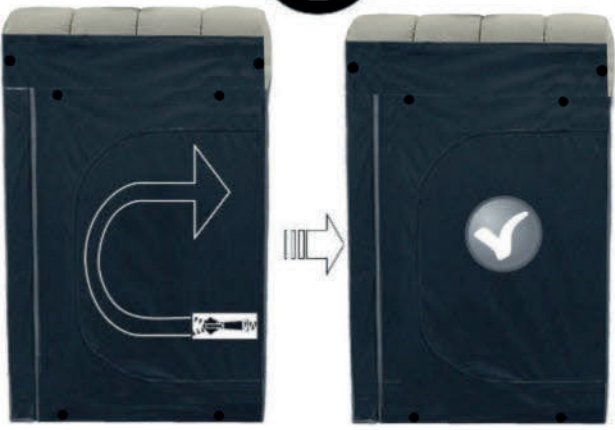

S3x4 B2x2

4



10-06-2026

 1h

 

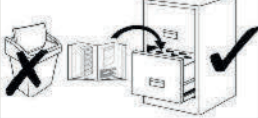

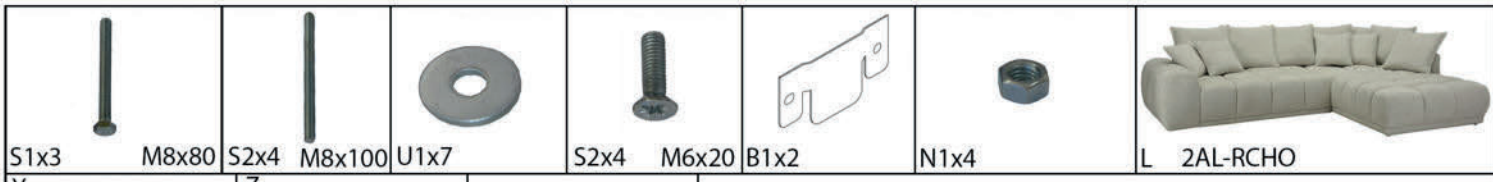

RCHO

5

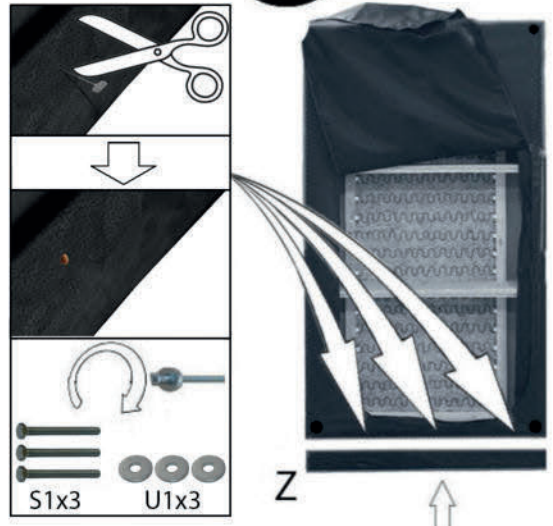

Z

7

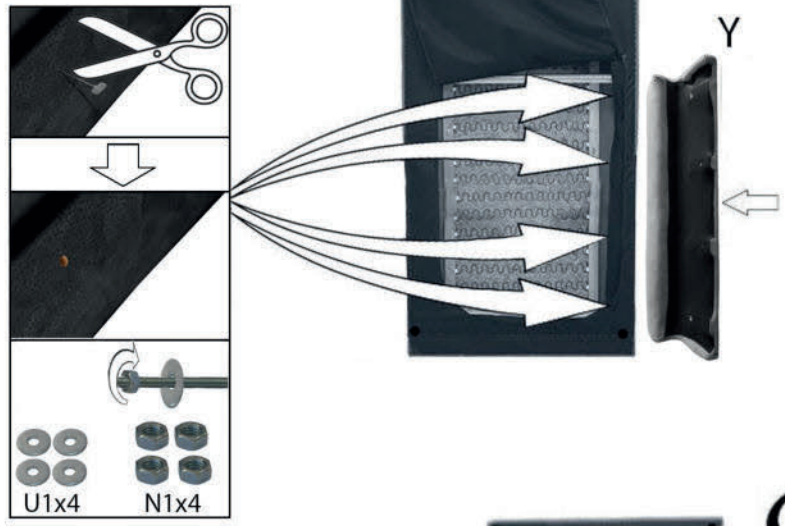

Y

U1x4 N1x4

6

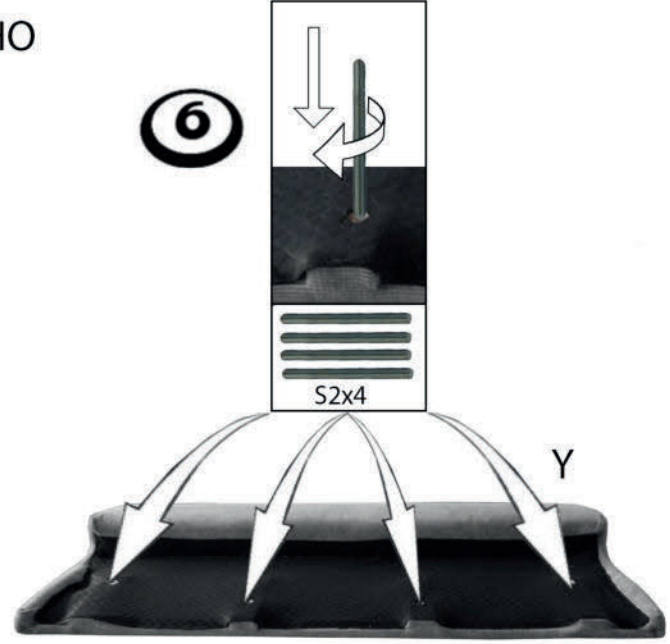

S2x4

Y

8

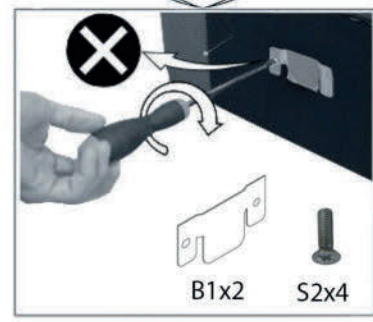

B1x2

S2x4

9

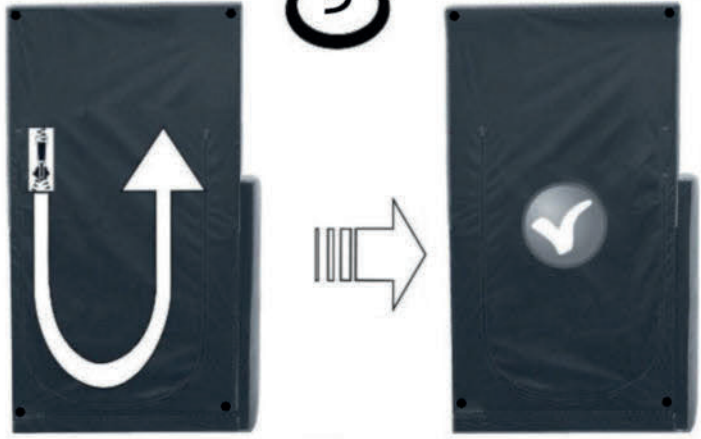

10-06-2026

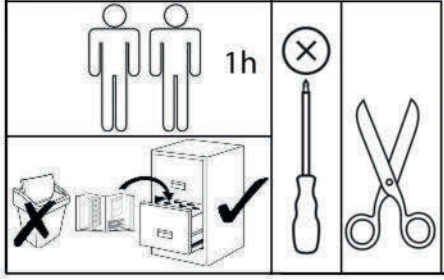

1h



L 2AL-RCHO

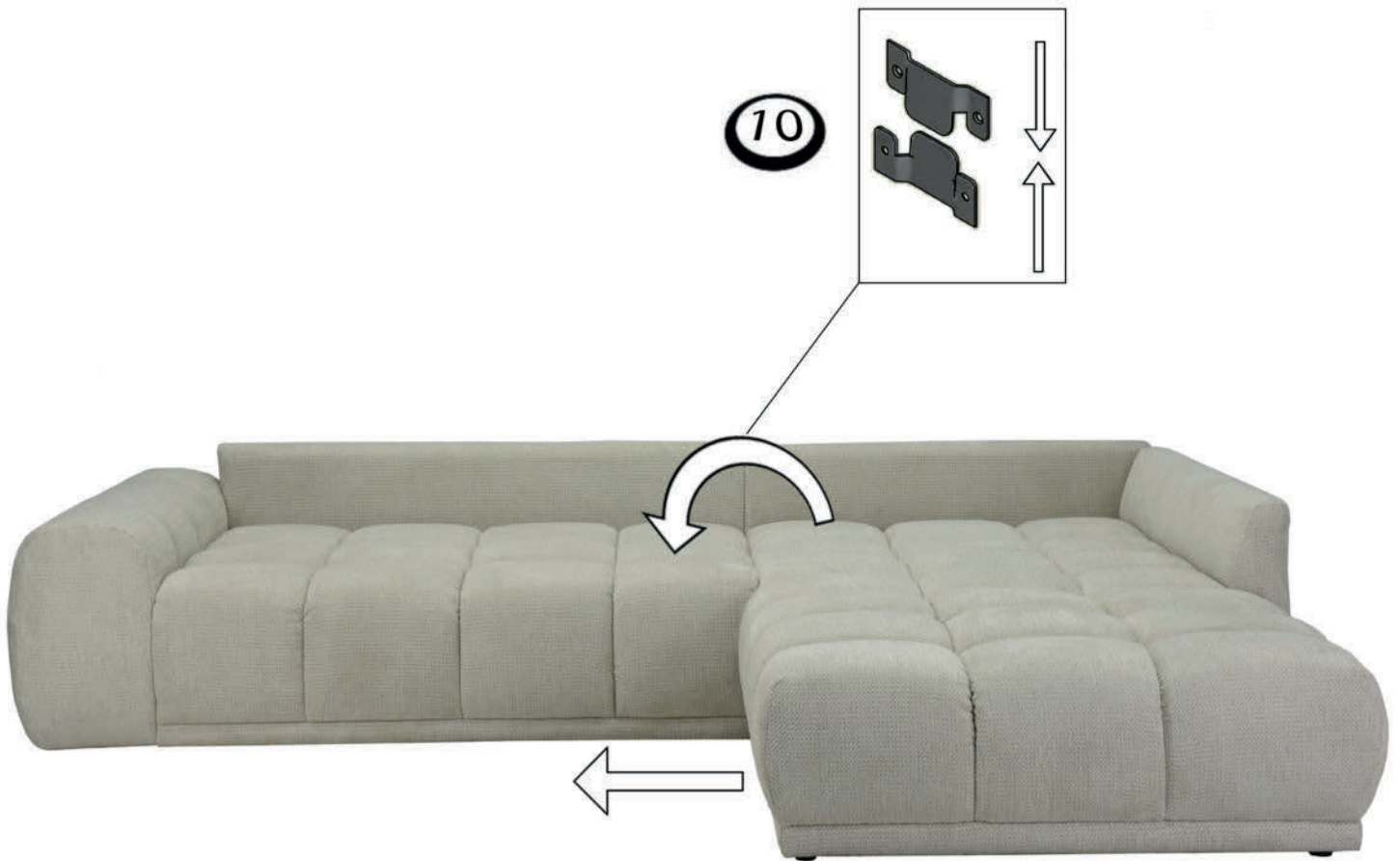

10-06-2026

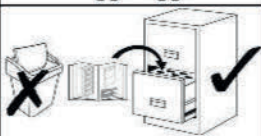
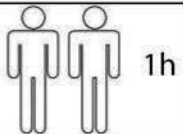

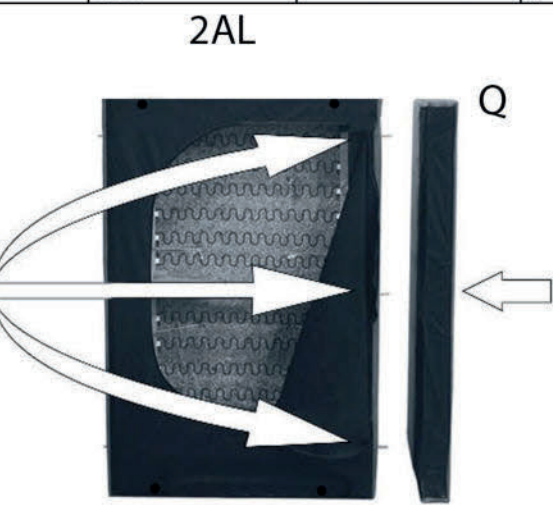
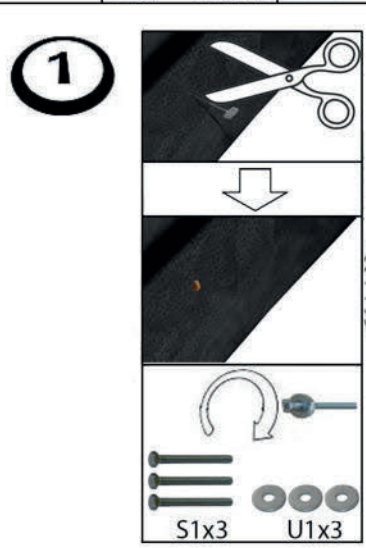
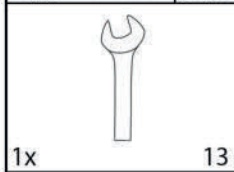
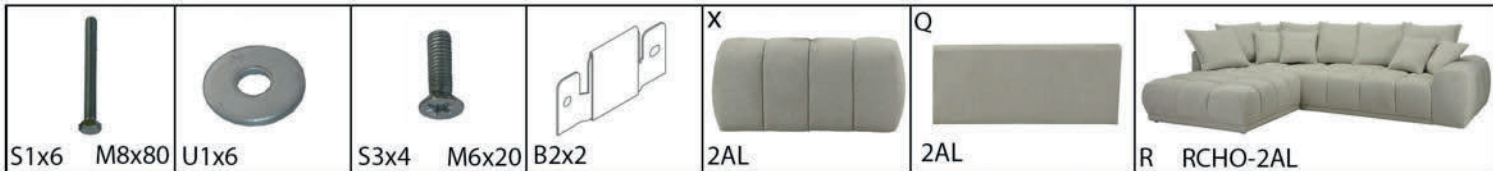

2

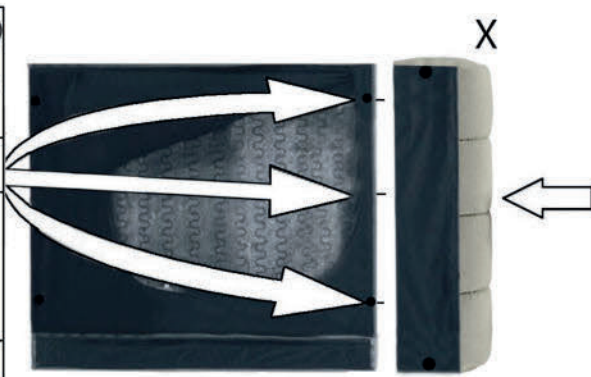
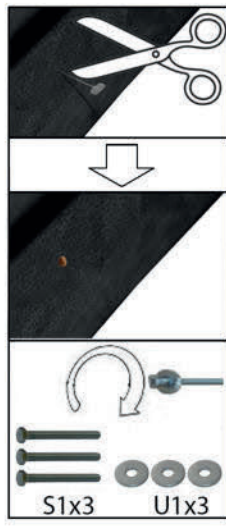

3

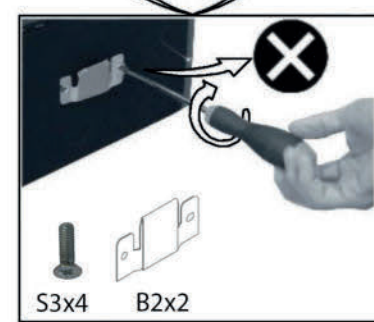
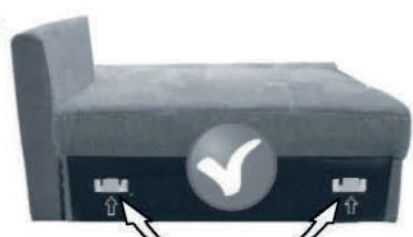

4



10-06-2026

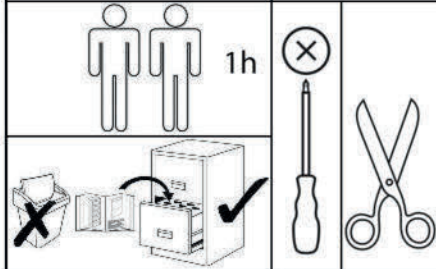



RCHO

6



S2x4

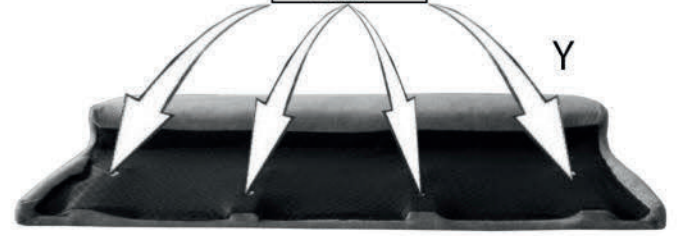

5

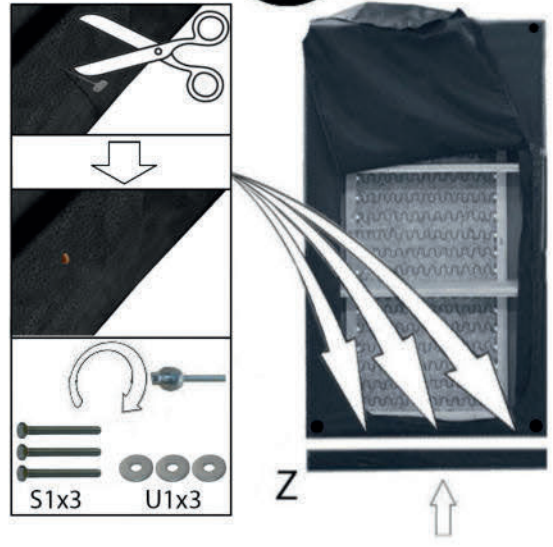

S1x3 U1x3

7

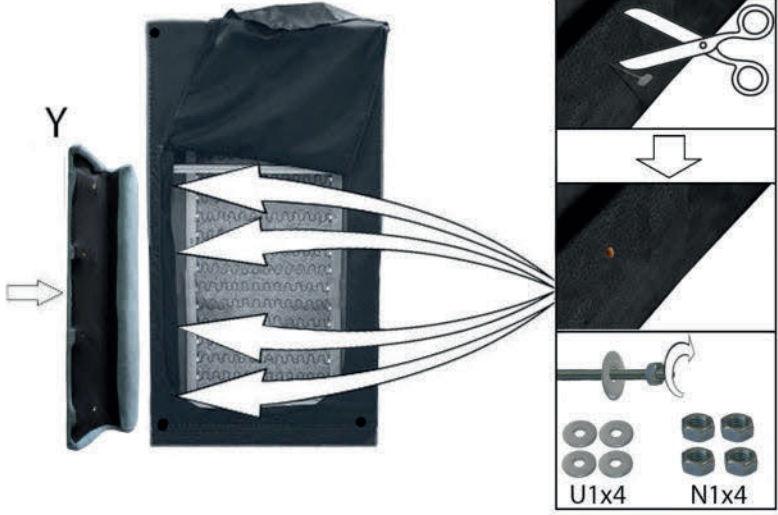

U1x4 N1x4

8

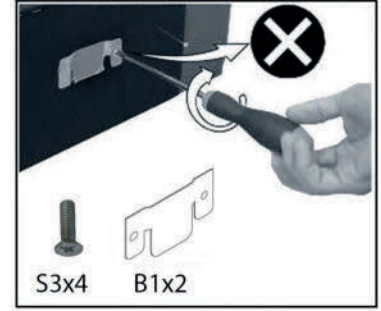

S3x4 B1x2

9



10-06-2026

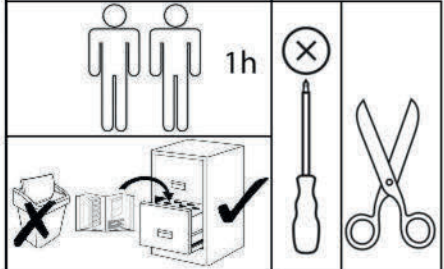



R CHO-2AL

10

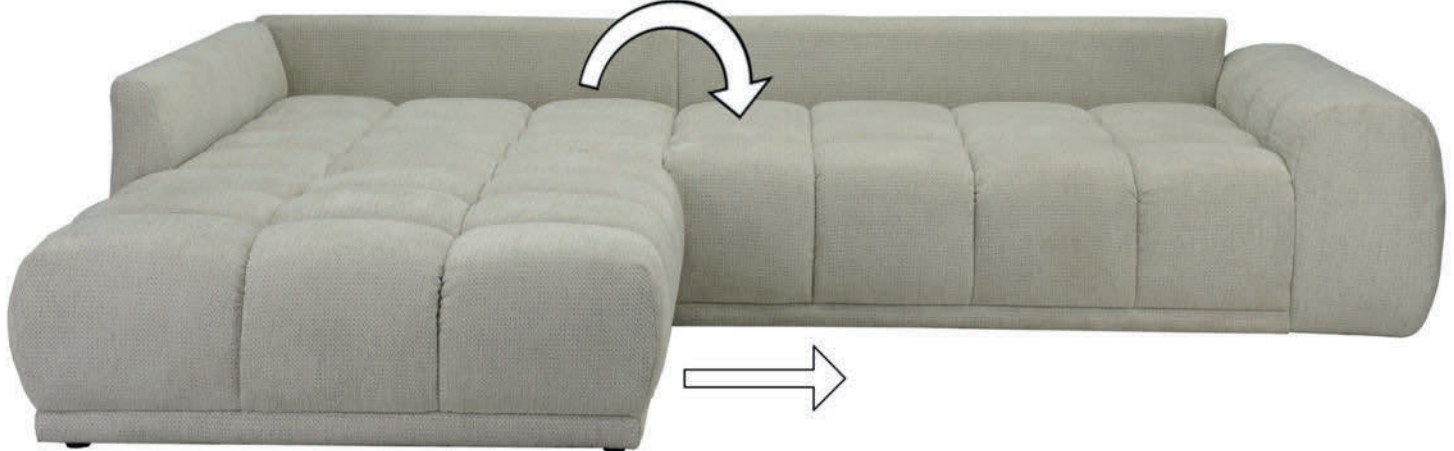
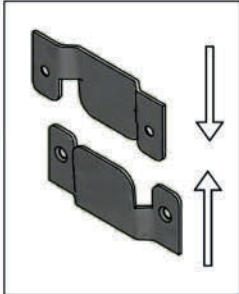

10-06-2026

