

TRENTO

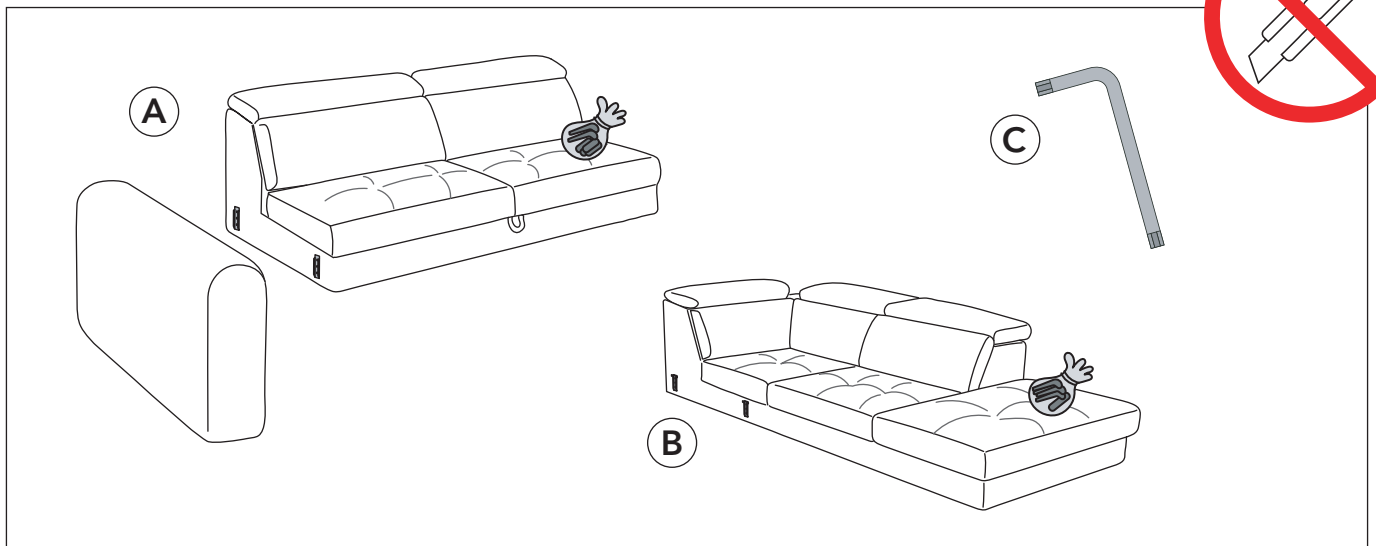

TRENTO

A - "PLAYA"

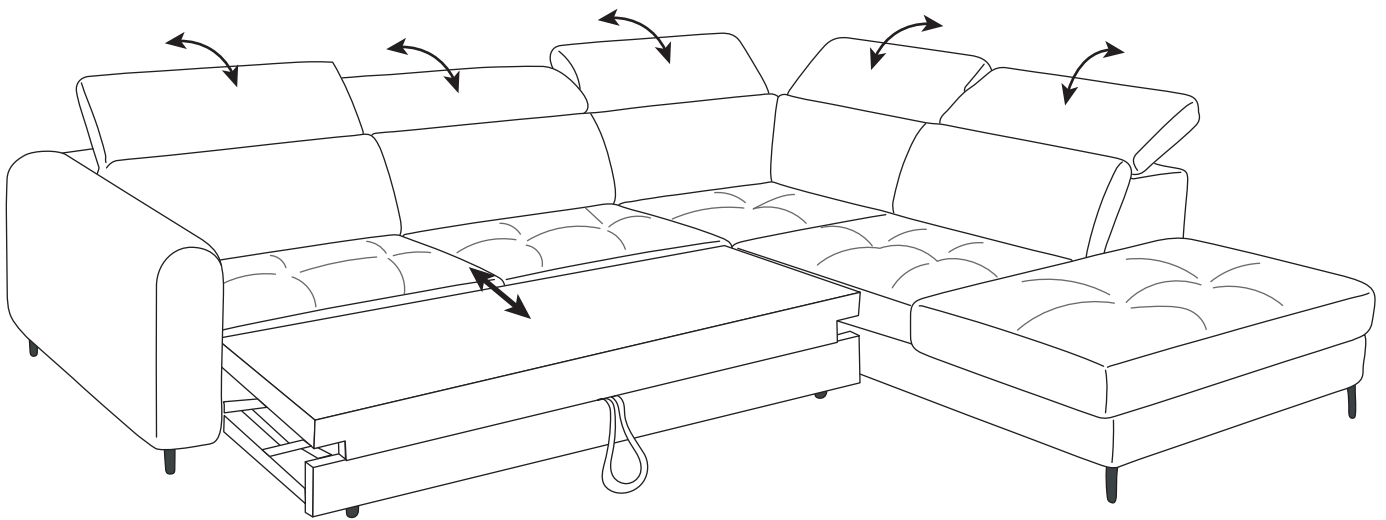
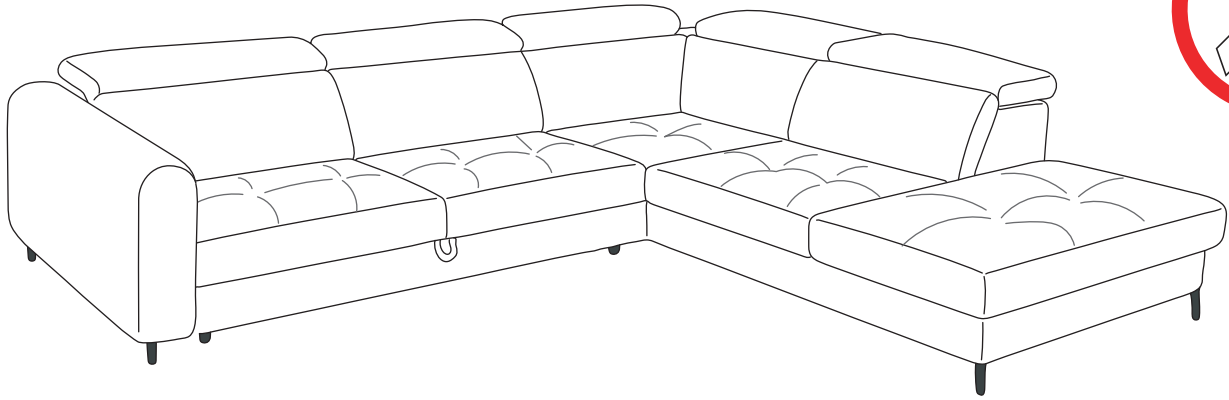
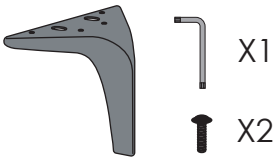

B

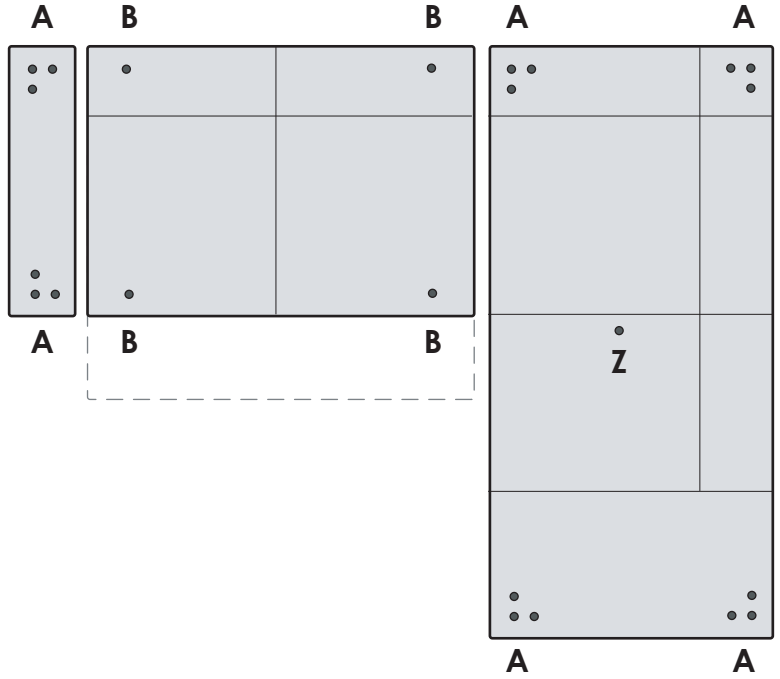

Z

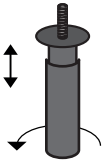

A

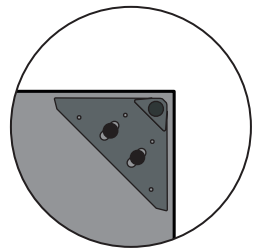
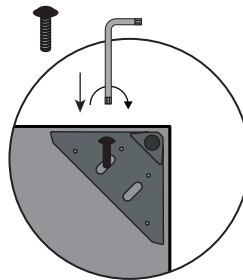
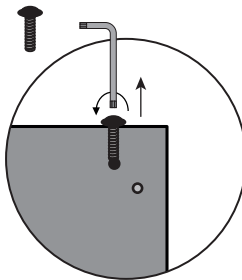
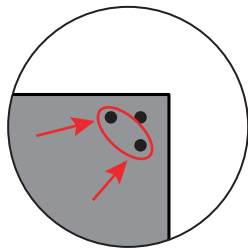
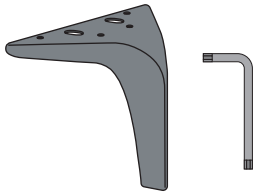

B

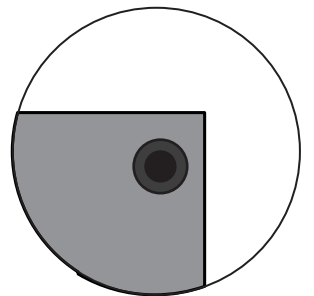
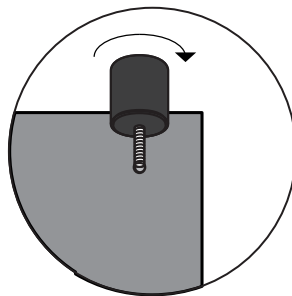
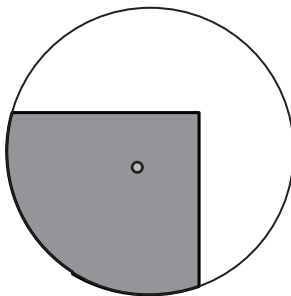

Z

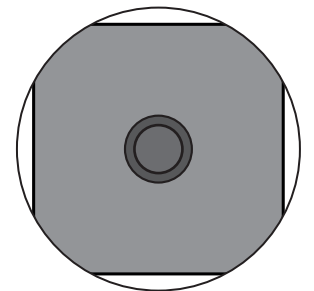
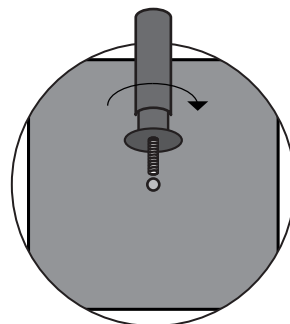
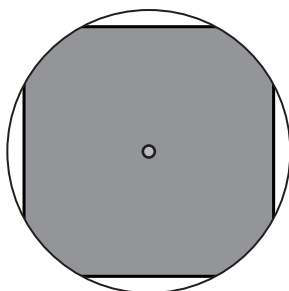
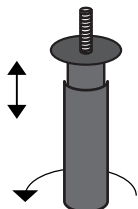

TRENTO

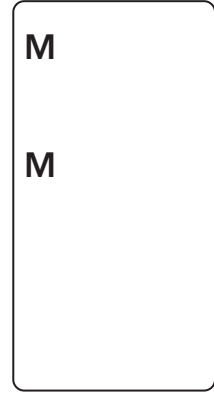
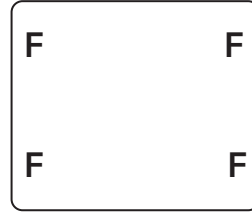
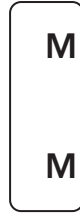
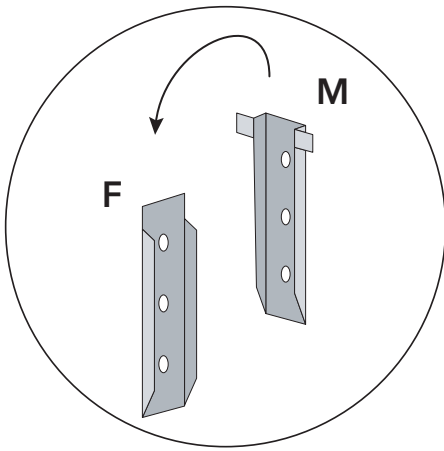

1

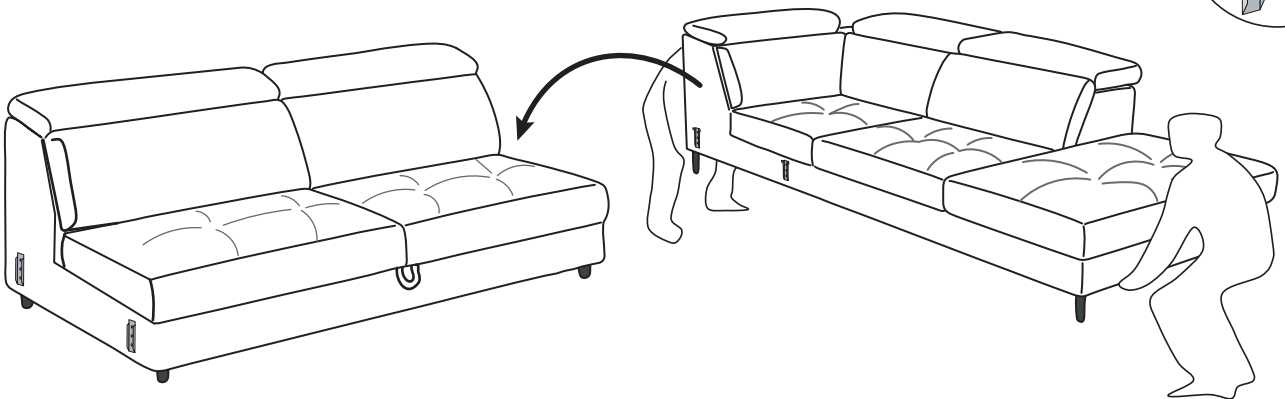
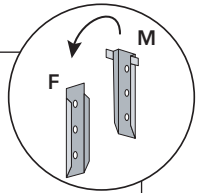

2

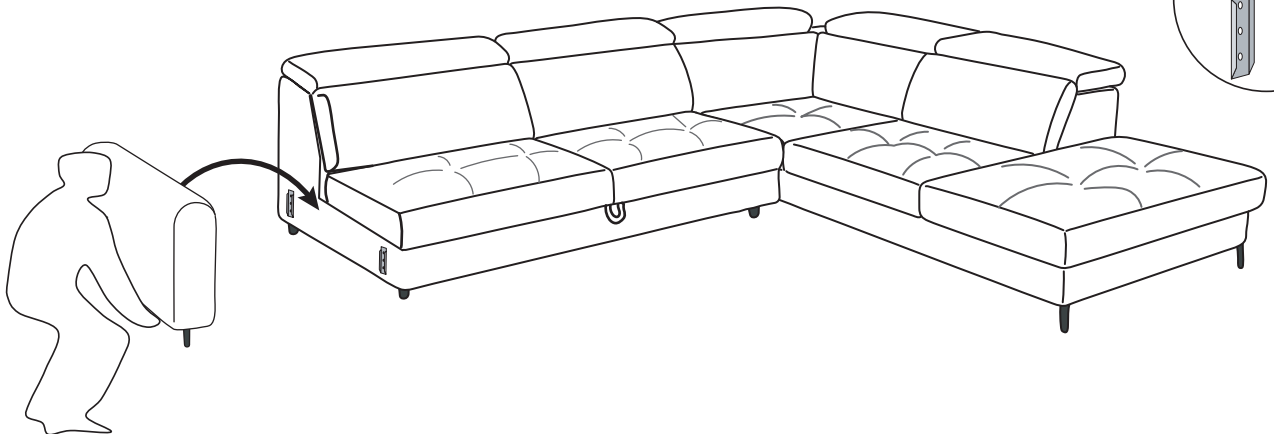
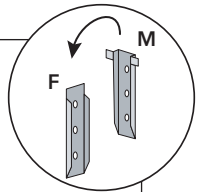

TRENTO

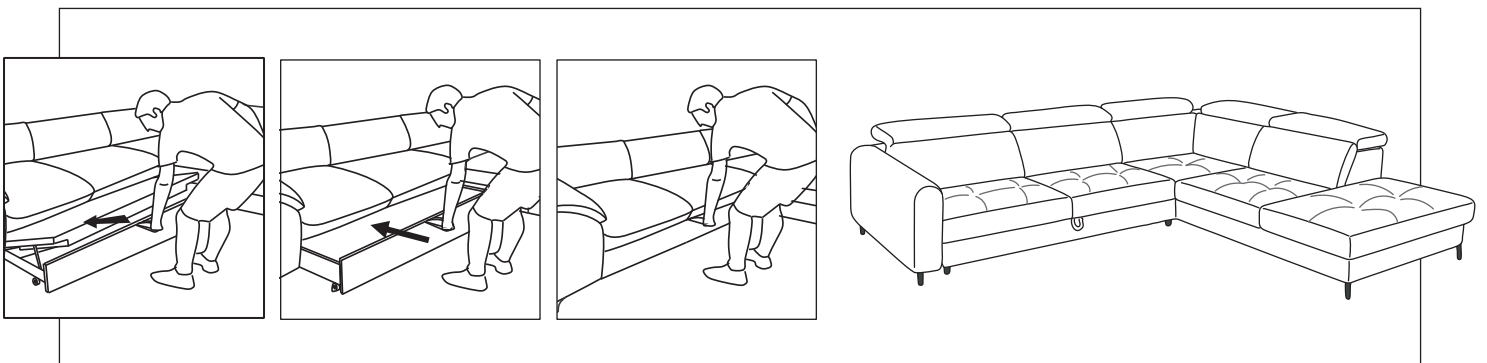
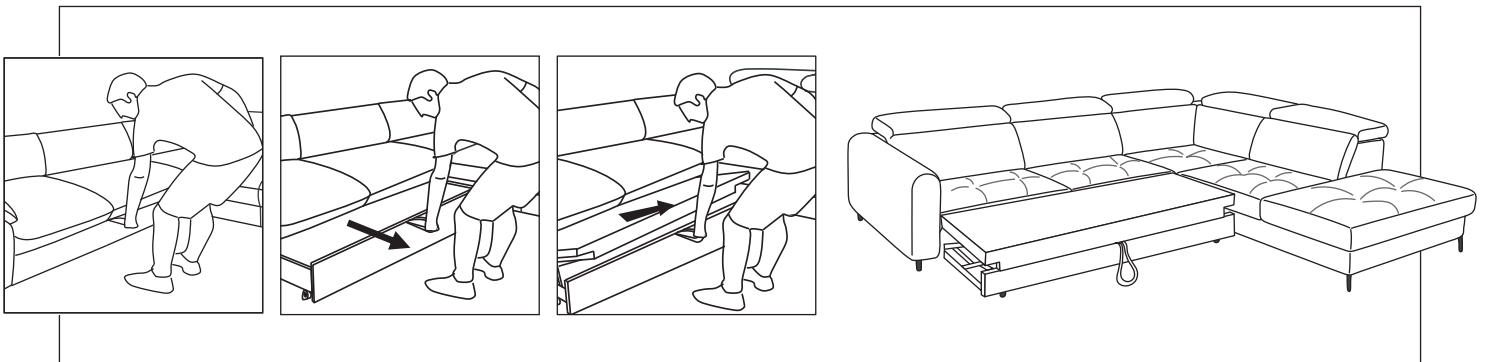
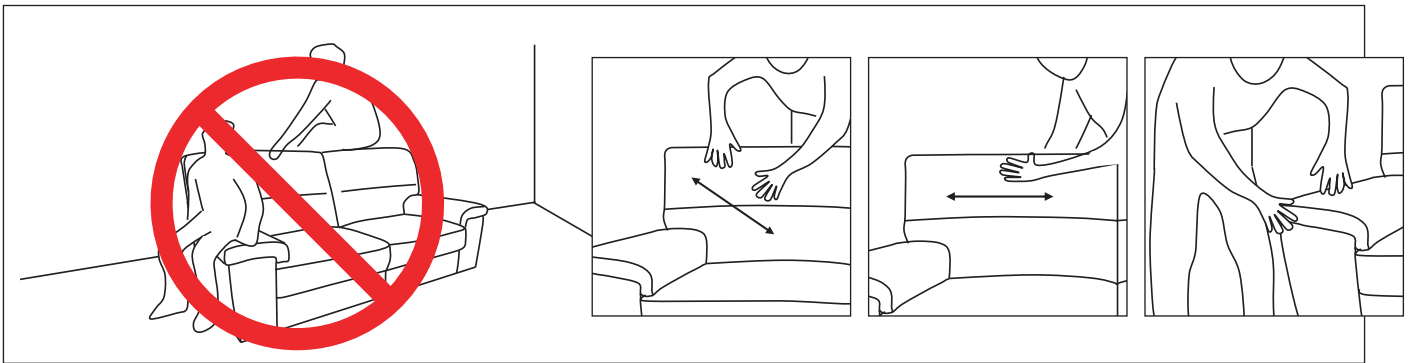
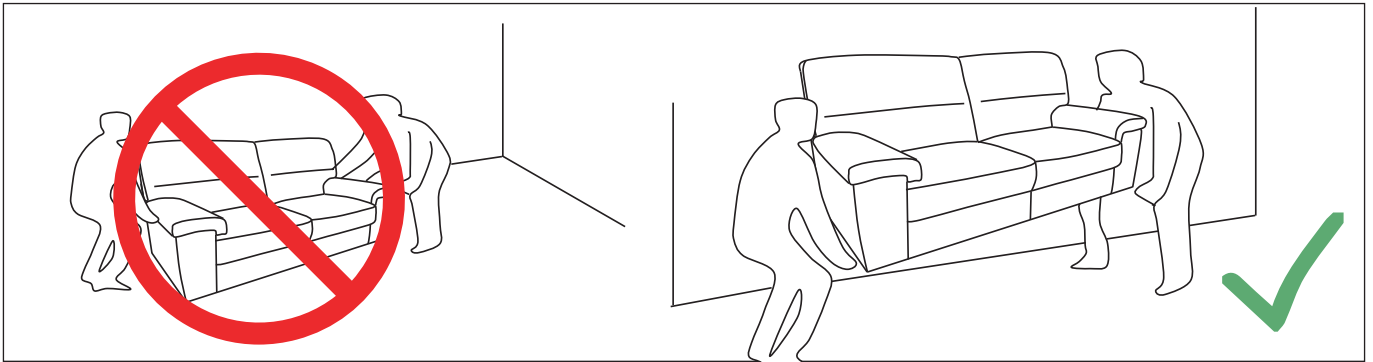
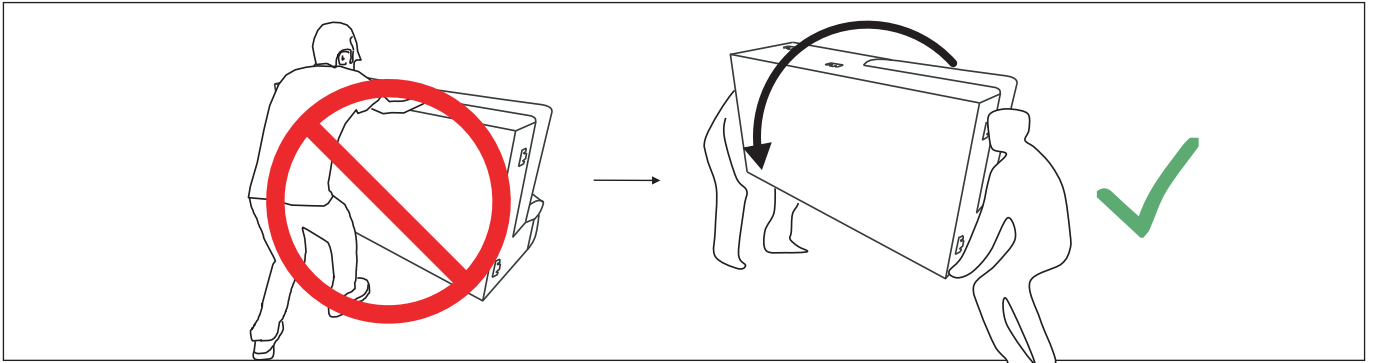

ATTENZIONE: Non permettere ai bambini di giocare sul divano azionato elettricamente o manualmente né di utilizzare i comandi elettrici o manuali senza sorveglianza. A causa del rischio di lesioni, assicurarsi che non sia presente nulla sotto il poggiatesta durante la sua chiusura. Lasciare sempre il divano in posizione chiusa e verticale. Soltanto l'occupante seduto puo' utilizzare i comandi di movimentazione.

CAUTION: Do not allow children to play unsupervised on this electronically or manual operated furniture or play with the electrical or manual remote control. Due to the risk of injury, make sure that there is nothing underneath the footrest when it folds down. Always leave the sofa in an upright and closed position. Only the occupant should operate the manual or electrical remote control.

ATTENTION: Ne permettez pas aux enfants de jouer sur ce canapé manuelle ou électrique ou de jouer avec le commande sans surveillance. A cause du risque de lésion, assurez--vous qu'il n y a rien au dessous du repose--pied lorsqu'il se referme. Laissez toujours le canapé en position vertical e et fermée. Seulement l'occupant devrait utiliser le commande manuelle ou électronique.

ACHTUNG: Kinder dürfen nicht ohne Kontrolle von Erwachsenen an diesem elektronisch oder manuellen betriebenen Sessel spielen oder die Fernsteuerung benutzen. Um Verletzungsgefahr zu vermeiden, soll man sich vergewissern dass sich beim Umklappen keine Gegenstände unter der Fußstütze befinden. Das Sofa ist immer senkrecht und geschlossen zu verlassen. Die Fernsteuerung ist nur vom Benutzer zu kontrollieren.

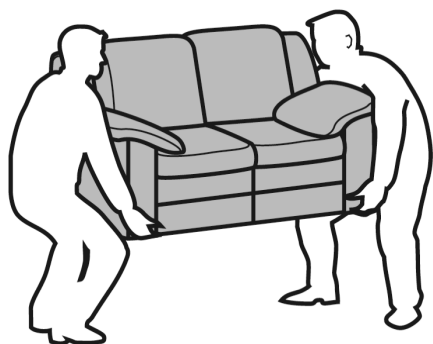
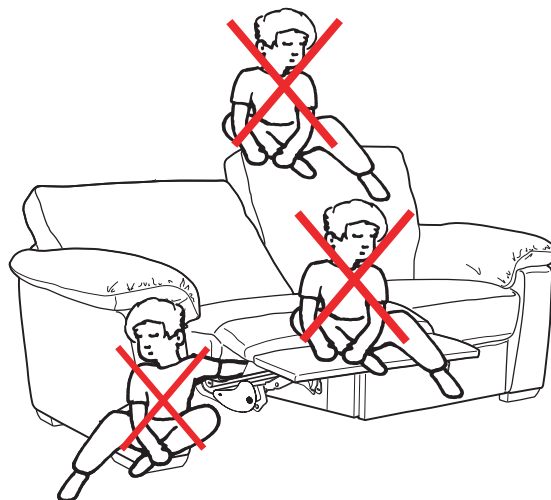

ATTENZIONE - ATTENTION - ACHTUNG - ATTENTION

SOLLEVARE IL DIVANO DAI LATI PER SPOSTARLO. NON TRASCINARE IL DIVANO. LA DITTA NON RISPONDE PER POSSIBILI DANNI ARRECATI DAI PIEDINI.

LIFT FROM THE SIDES TO MOVE THE SOFA. DO NOT DRAG THE SOFA. THE COMPANY IS NOT RESPONSIBLE FOR POSSIBLE DAMAGE CAUSED BY FEET.

UM DAS SOFA ZU BEWEGEN, BITTE HEBEN SIE DAS SOFA VON DER SEITEN AUF. CHLEPPEN SIE DAS SOFA NICHT. DIE FIRMA HAFTET NICHT FÜR MÖGLICHE SCHADEN, DIE VON DEN FÜßEN VERURSACHT WURDEN.

