

G 093 / G 112

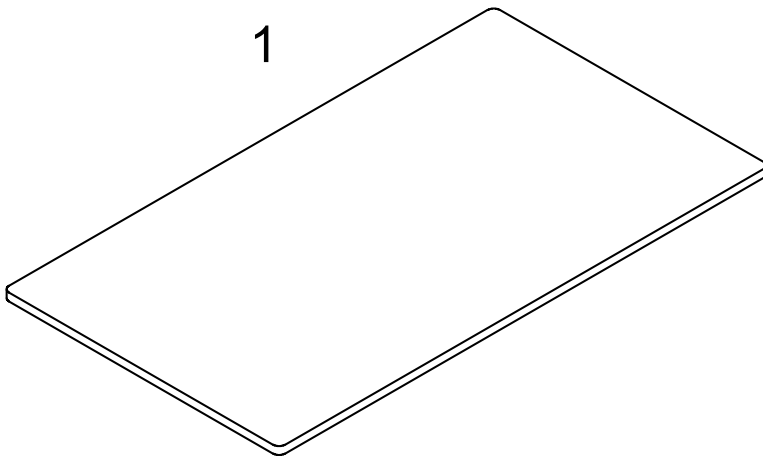

2.1

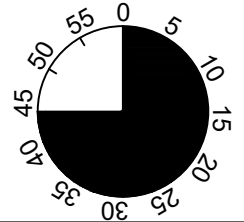

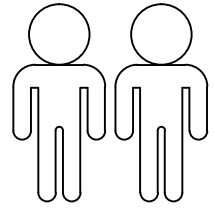
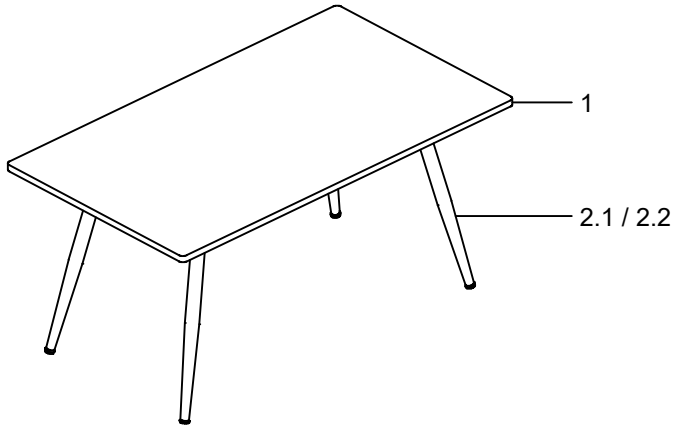
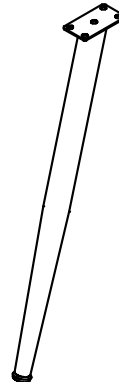

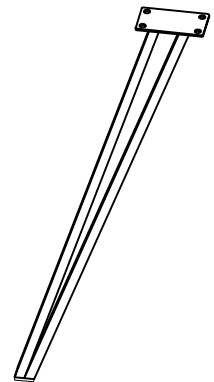



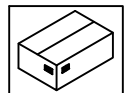
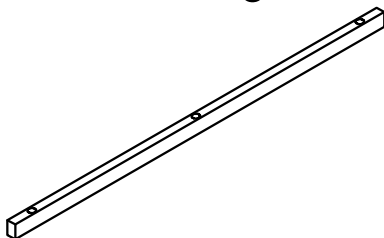

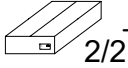

2.2

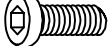

3







1	1X	1/2
2.1/2.2	4X	2/2
3	2X	2/2

 2/2	A  M6x12 6x	B  M8x12 16x	C  M6x35 6x	D  M8x16 16x	E  Ø18xØ8x1.5 16x
F  Ø25 (2.2) 4x	G  Ø18xØ6x2.5 2x	H  5MM 1x	I  6MM 1x	J  8MM 1x	

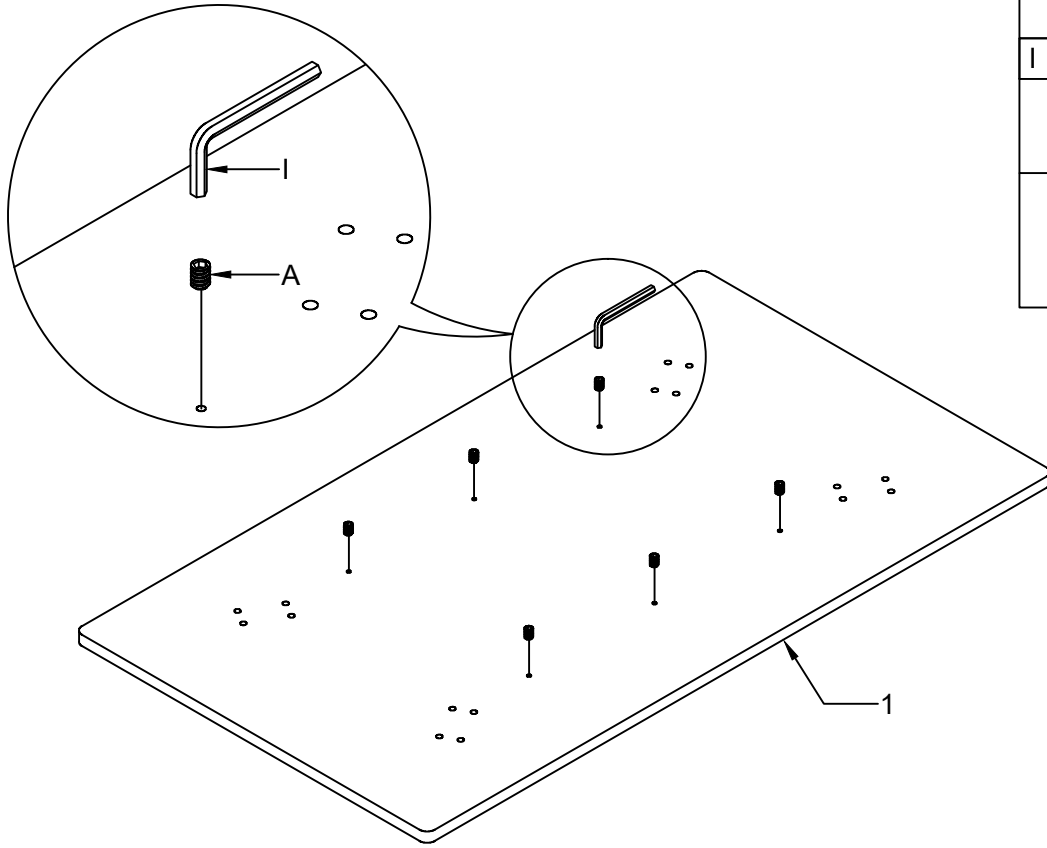
I.





1.

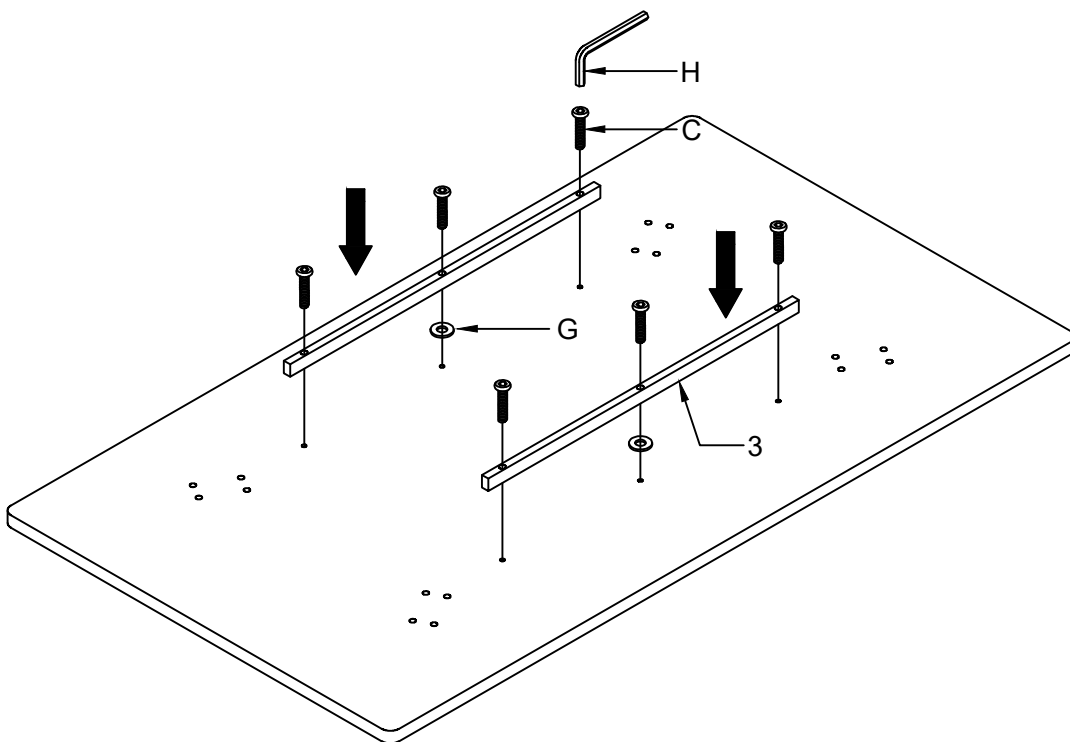

A	M6x12
	6x
I	6MM
	1x
	

2.





G	Ø18xØ6x2.5	C	M6x35
	2x		6x
		H	5MM
			1x
			

II.

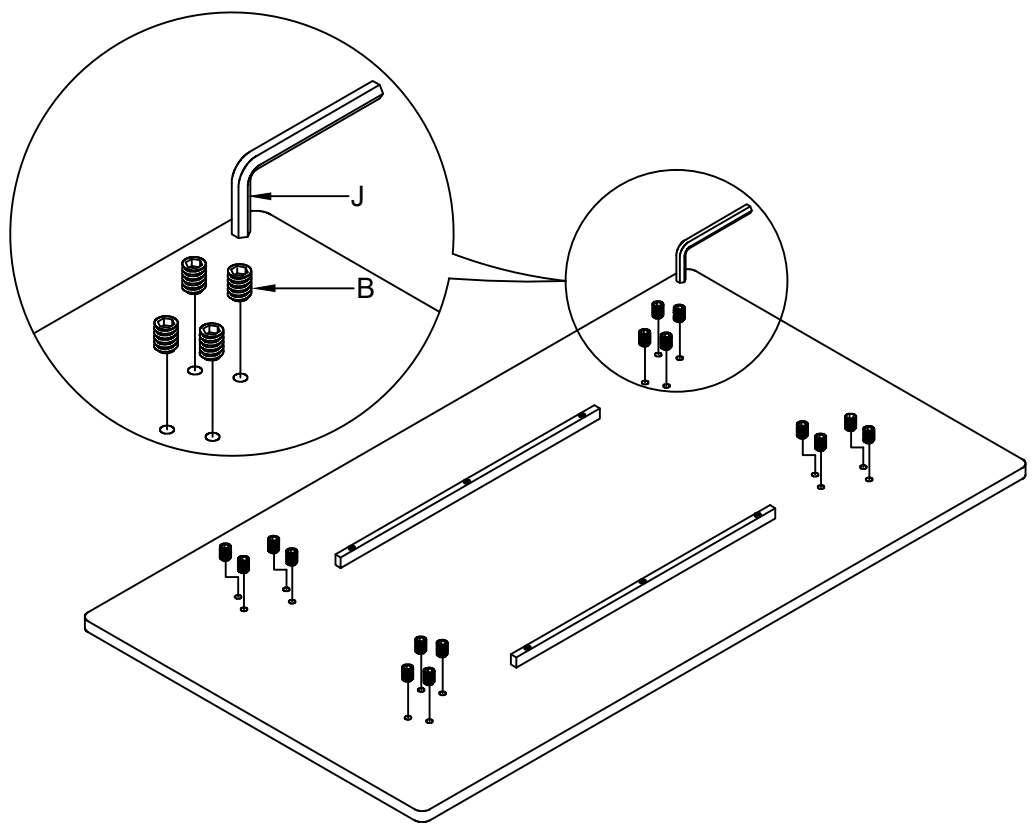

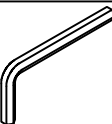
3.

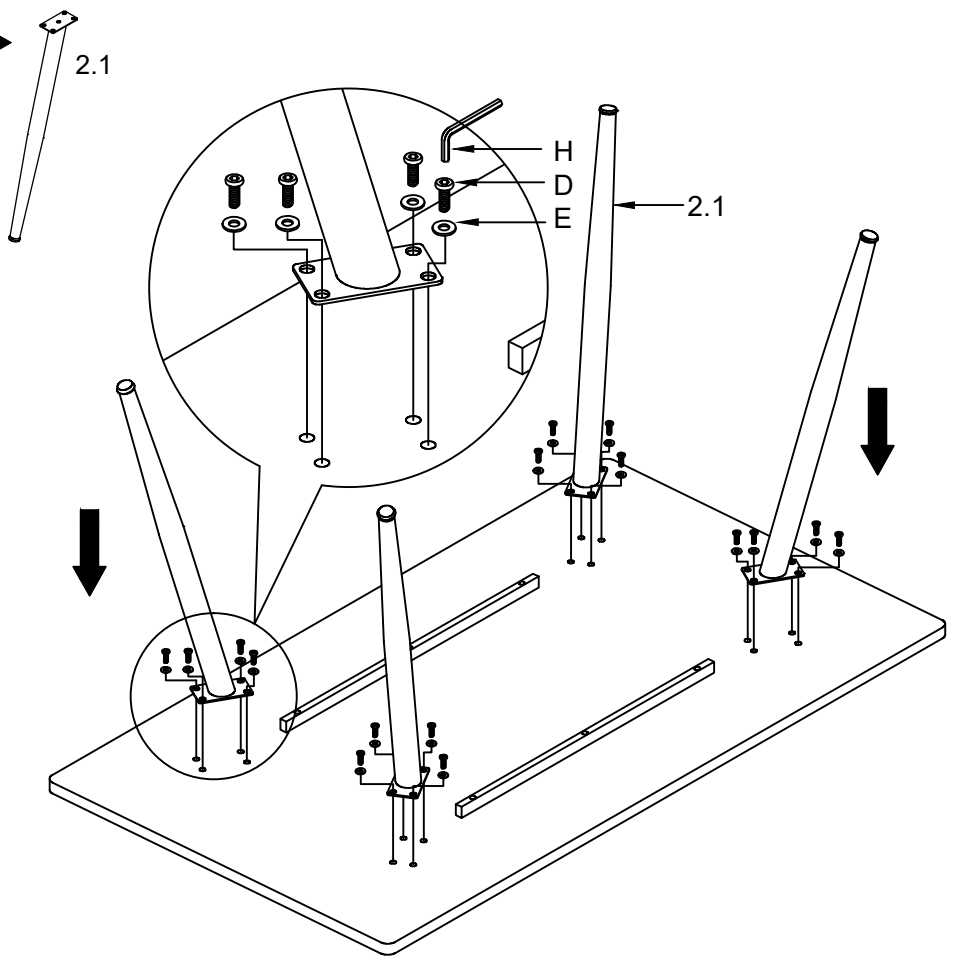

B	M8x12
	16x
J	8MM
	1x
	

4.1 →

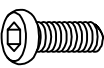

D	M8x16
	16x
E	Ø18xØ8x1.5
	16x
H	5MM
	1x
